

HILTI

Dust
Solutions that increase
working comfort,
safety and productivity



DARS

Less dust. More productivity.

Hilti. Outperform. Outlast.

**Dust can influence comfort, safety and productivity.
Keep dust under control – with Hilti.**

Dust can't be ignored.

Dust is generated by many of the processes carried out in the construction industry such as cutting, grinding, slitting or breaking. At a minimum, this can result in an uncomfortable work environment. While these issues are well known, controlling airborne dust has historically been a challenge.

Another important aspect is that dust can have a negative impact on the lifetime of power tools and consumables or on the working processes on the job site (non-working time or additional labor time for cleaning), which can result in reduced productivity and higher costs.

Keep dust to a minimum – with Hilti.

Hilti is committed to helping you reduce the risks your workforce is exposed to, and increase your productivity on site – with product and service solutions that greatly reduce exposure to dust in many everyday jobs on the construction site. It's time to take advantage of all the benefits of Hilti dust removal systems – because dust can be a hazard and a costly issue that simply can't be ignored.

**For increased working comfort,
safety and productivity!**

Keep dust under control!

Less dust on the job site means

- higher comfort and better protection for the workers
- a more precise and efficient working procedure
- less valuable working time spent cleaning up afterwards

Efficient dust removal helps

- increase the lifetime of power tools and consumables
- reduce tool downtime
- cut the cost of repairs and maintenance

A high-performance, easy-to-use dust removal system allows

- efficient and productive use (reduction of labor time)
- less time and money spent on training and instruction
- fewer sources of error / incorrect handling

Wide range of solutions.

Hilti offers comprehensive solutions that keep dust to a minimum in virtually every conceivable job on the construction site such as grinding, slitting, cutting or breaking, to name only a few.



When we say systems, we mean systems!

Four components – one winner. Hilti DRS dust removal systems make countless jobs virtually dustless. All system components, including power tools, drill bits, discs, blades or other accessories as well as fully integrated systems, are perfectly matched to maximize the amount of dust removed at its source and collected efficiently by the vacuum removal system.

These are the four components of the Hilti system – the system that wins hands down. Dust simply doesn't stand a chance!

DRS Dust Removal Systems



1. The consumables

2. The power tool

3. The accessories

4. Hilti vacuums

Hilti. Outperform. Outlast.

Hilti, Inc. (U.S.) 1-800-879-8000 www.us.hilti.com • en español 1-800-879-5000
Hilti (Canada) Corp. 1-800-363-4458 • www.hilti.ca

Hilti. Outperform. Outlast.

Hilti, Inc. (U.S.) 1-800-879-8000 www.us.hilti.com • en español 1-800-879-5000
Hilti (Canada) Corp. 1-800-363-4458 • www.hilti.ca

Optimum dust reduction begins with the consumables.

Hilti consumables are not just cleverly designed – they're revolutionary, highly efficient and deliver top performance. The DG-CW 6" diamond cup wheel is a perfect example. The special design of these cup wheels provide effective dust removal, optimum cooling of the segments and top working comfort. Materials such as tile adhesive can be removed and the underlying surface prepared in a single operation. Hilti cup wheels combine maximum performance with minimum dust emissions to form a proven system that helps save time and costs again and again.

The low-dust generation

Air turbulence and air flow are defined exactly by the special boomerang shape of the diamond segments – for best-possible dust removal performance.



DRS It's the details that count.

Four-way helical flutes

Hilti TE-C3X hammer drill bits feature four carbide cutting edges and innovative X-geometry. Each cutting edge leads into its own helical flute, ensuring extremely efficient removal of dust and fragments, thus contributing to Hilti's legendary drilling performance.



Built-in air channels

The new Hilti DD-B core bit generation is simply in a class of its own. In addition to this obvious, measurable drilling performance advantage, these core bits feature built-in DRS air channels that extract the dust right at its source, from inside the core bit, for efficient collection by the dust removal system.



Spectacular power tool design helps put an end to the dust problem.

The Hilti DCH 300 diamond cutter is an example of dust-reducing power tool design in perfection. With its ability to cut to depths of up to 4-3/4 in. and advanced ergonomic design, it completely redefines this tool category. The way in which the specially shaped hood works together with the blade to capture the dust the moment it is generated, ready for immediate removal, is amazing. But that's not all. This exceptional dust removal efficiency also helps extend the life of the blade, improves its cutting performance and therefore raises productivity.

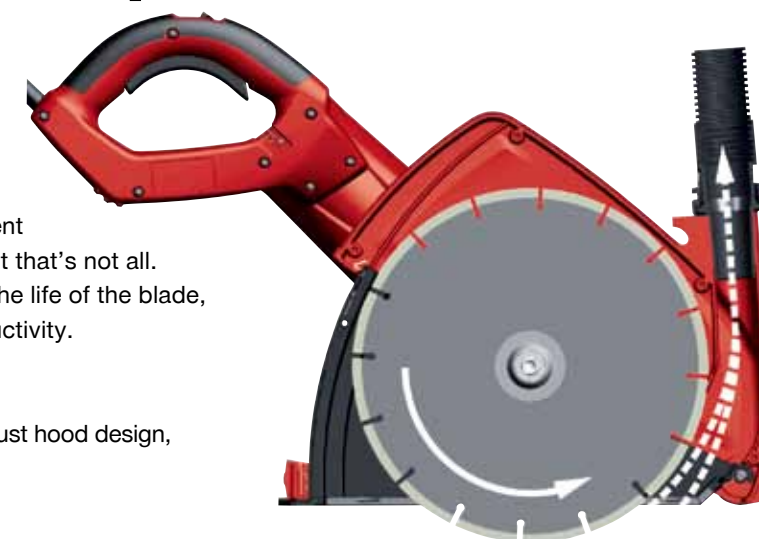

Aerodynamic hood design

Thanks to the new blade rotation direction and aerodynamic dust hood design, dust doesn't stand a chance.

DRS Hilti power tools remove dust at its source.

Bad news and good news

First the bad news: Slitting work, also known as chasing, generates a huge amount of dust. Now the good news: With the Hilti DCH 230, dust is removed right at its source. Quickly, cleanly and reliably. This is yet another example of how Hilti tools – in conjunction with Hilti vacuum cleaners – are capable of maintaining a cleaner working environment.



Clean cut

Maximize your productivity by keeping dust under control thanks to Hilti dust controlled cutting and grinding systems. Whether you are tuck pointing, cutting or finishing concrete, these easy-to-use systems will help you reduce dust to a minimum and increase productivity to the maximum.



High-tech inside

The Hilti DG 150 offers unmatched grinding performance. The main reason for this is its advanced engineering and the resulting optimization of the air-flow inside the tool's built-in dust removal hood – for extraction of dust through the openings in the cup wheel.



Hilti. Outperform. Outlast.

Hilti. Outperform. Outlast.

Fine dust can be hazardous. Hilti accessories get rid of most of it.

To describe the first professional-grade dust removal system for breakers as an “accessory” is probably something of an understatement. One thing we certainly won’t understate, however, is the effectiveness of the extremely robust and durable Hilti TE DRS-B. Made from special pliable materials and featuring a unique, keyless quick-release mounting system, this dust removal attachment keeps dust during demolition work to a minimum.

Dual-chamber dynamic air-flow system

Our engineers describe it as a “unique, dual-chamber dynamic air-flow system”. Our customers simply call it “dust controlled chiseling”.

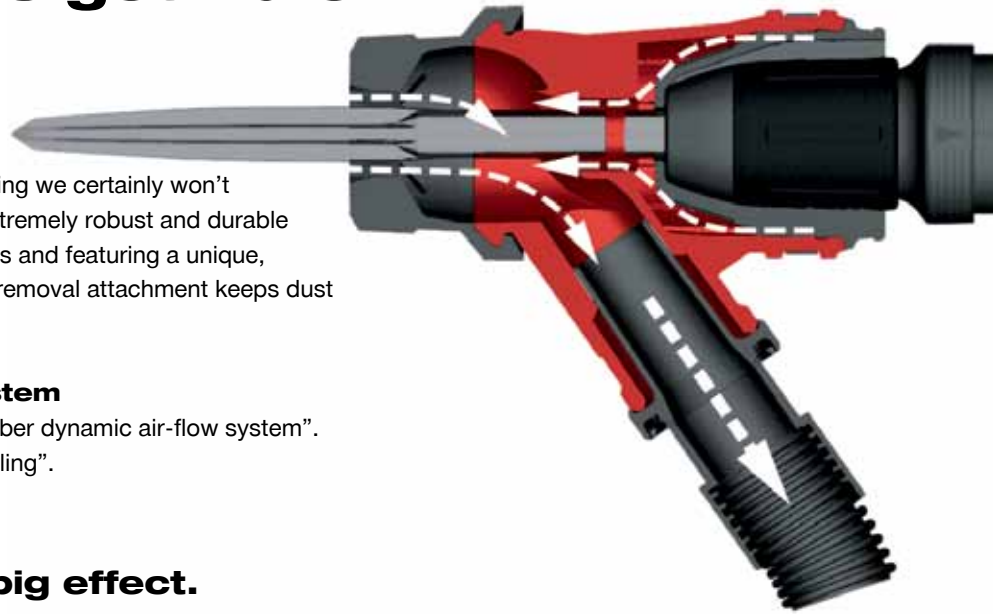

DRS Small extras, big effect.

Self-contained

The professional-grade TE DRS-M dust removal attachments for Hilti rotary hammers are compact and very convenient. These attachments are powered by the rotary hammer’s own motor, so no separate vacuum cleaner is required.

Indispensable

Power under the hood for grinders and slitters: The new DC EX and DG EX dust removal hoods from Hilti are a pleasure to use – and keep dust to a minimum.

Versatile

Solutions for a wide range of applications. From grinding, cutting, drilling and chiseling, Hilti DRS systems suit many needs.



Hilti AirBoost filters give dust the push every 15 seconds.

It’s like a dream come true: Compact, mobile and robust vacuum cleaners with continuous high suction performance. Their new state-of-the-art filter technology briefly reverses the flow of air inside the system and thus blasts the filter clean every 15 seconds – automatically. Powerful, ruggedly built and highly efficient, these vacuum cleaners take hard, everyday jobsite use in their stride, feature a practical design and provide compatibility with virtually all Hilti power tools.

Hilti AirBoost filter technology

Hilti AirBoost filter technology lays the foundation for a clean, virtually dustless workplace. A modified container concept also keeps dust to a minimum when emptying.

HEPA Filtration System

Add the optional HEPA filter and HEPA fleece bags and your VC 20-U / VC 40-U become a self-contained HEPA system.



DRS Professional Vacuums

VC20-U - the compact marvels

The new VC 20-U wet/dry vacuum cleaners remove dirt and dust of all kinds in drilling, slitting, grinding, sanding, cutting or coring jobs. Their modified container concept allows full use of the capacity available and makes emptying a virtually dustless operation.

VC40-U - the powerful all-rounders

The versatile VC 40-U vacuum cleaners are the ideal solution for hard, everyday jobsite use and provide a container volume of 6 gallons and effective dust capacity of 80 lbs. Their large wheels are only one of the many features that indicate their construction industry pedigree.



Hilti. Outperform. Outlast.

Hilti. Outperform. Outlast.

Dust Removal Systems

Drilling

TE 2
Rotary Hammer Drill



TE 6-A36 AVR
Rotary Hammer Drill



TE 7-A
Rotary Hammer Drill



TE 7
Rotary Hammer Drill



TE 30-C-AVR
Rotary Hammer Drill



TE 40-AVR
Combihammer



Combi & Demolition Hammers

TE 50
Combihammer



TE 60-ATC-AVR
Combihammer



TE 70-ATC
Combihammer



TE 80-ATC-AVR
Combihammer



TE 500
Demolition Hammer



TE 706-AVR
Demolition Hammer



TE 805
Breaker



TE 1000-AVR
Breaker



TE 1500-AVR
Breaker



Diamond Coring

DD 110-D
Diamond Coring Tool



DD 120
Diamond Coring Tool



DD 130
Diamond Coring Tool



DD 200
Diamond Coring Tool



EC-1
Diamond Coring Tool



DD 110-W
Diamond Coring Tool



Diamond Cutting

DCH 230
Electric Saw



DCH 300
Electric Saw



DSH 700
Gas Saw



DSH 900
Gas Saw



Grinding, Cutting & Tuck Pointing

DEG 500-D
Angle Grinder



DAG 500-D
Angle Grinder



DCG 500-S
Angle Grinder



DG 150
Diamond Grinding System



DCG 700-P
Angle Grinder*



DAG 700-P
Angle Grinder*









Wet system for dust control

* Available on special order







Hilti. Outperform. Outlast.

Hilti. Outperform. Outlast.

Accessories needed for dust removal drilling

Description	TE 2	TE 6-A36 AVR	TE 7	TE 7-C	TE 7-A	TE 30/30-C	TE 40-AVR/40-C	Item No.
TE DRS-S 	■					■	■	00340602
TE DRS-M 			■	■	■			00267769
TE DRS-6A 		■						
Extraction Head 3/16" - 1" hole dia. 	■					■	■	00340605
Extraction Head 1" - 3-1/4" hole dia. 						■	■	00340606
Spare parts pack TE DRS-S (optional)	■						■	00340603
VC 20-U 	■					■	■	00222428
VC 40-U 	■					■	■	00218369
TE 6-A36 AVR Professional Kit - Includes tool, TE DRS-6-A dust removal system, (2) B 36 Li-Ion 3.0-Ah batteries, C 4/36-ACS Li-Ion (TPS) charger & (4) TE-CX bits: 3/8" x 6" (1), 5/8"-6" (2), 1/2"-6" (1)		■						03471838
TE 7 120V + DRS Performance Package (Fixed) - Includes tool, DRS System & (3) TE-CX bits: 3/8"-6" (1), 1/2"-6" (2), 1/4"-6" (1)			■					03471833
TE 7-C 120V + DRS Performance Package (Fixed) - Includes tool, TE DRS-M & (2) TE-CX bits: 3/8"-6" (1), 1/2"-6" (1)				■				03476286
TE 7-A CPC Professional Kit - Includes tool, TE DRS-M, (2) B 36/3.9AH Li batteries, C 4/36-ACS-TPS charger & (3) TE-CX bits: 3/8"-6" (1), 1/2"-6" (1), 5/8"-6" (1) & (1) TE-CP SM 18 chisel					■			03476241

Accessories needed for dust removal drilling and demolition

Description	TE 50	TE 60/60-ATC	TE 70/70-ATC	TE 80-ATC	TE 500	TE 706-AVR	TE 805	TE 1000	TE 1500	Item No.
TE DRS-S 	■	■	■	■						00340602
DRS Depth Gauge For use with TE-DRS-S for TE 70 and TE 80 Combihammers 			■	■						00410332
Extraction Head 3/16" - 1" hole dia. 	■	■	■	■						00340605
Extraction Head 1" - 3-1/4" hole dia. 	■	■	■	■						00340606
TE DRS-B 	■	■	■	■	■	■	■	■	■	00365944
VC 20-U 	■	■	■	■	■	■	■	■	■	00222428
VC 40-U 	■	■	■	■	■	■	■	■	■	00218369
TE 500 Dust Control Package - Includes tool, (1) TE-YP SM 36 pointed chisel, (1) TE-YP FM 36 flat chisel & DRS-B dust removal system					■					03451004
TE 706-AVR Dust Control Package - Includes tool, (1) TE-YP SM 36 pointed chisel, (1) TE-YP FM 36 flat chisel & DRS-B dust removal system						■				03451003
TE 1000-AVR Dust Control Package Deluxe - Includes tool, (1) TE-SP SM 36 pointed chisel, (1) TE-SP FM 36 flat chisel, VC 40-U Vacuum & DRS-B dust removal system								■		03450919
TE 1000-AVR Dust Control Package - Includes tool, (1) TE-SP SM 36 pointed chisel, (1) TE-SP FM 36 flat chisel & DRS-B dust removal system								■		03450920
TE 1500-AVR Dust Control Package Deluxe - Includes tool, TE-SP SM 36 pointed chisel, TE-SP FM 36 flat chisel, VC 40-U Vacuum & DRS-B dust removal system									■	03457407
TE 1500-AVR Dust Control Package - Includes tool, TE-SP SM 36 pointed chisel, TE-SP FM 36 flat chisel & DRS-B dust removal system									■	03457406

Accessories needed for dust removal coring, cutting and grinding

Description	DD 110-D/W	DCH 230	DCH 300	DG 150	DAG 500-D	DCG 500-S	DEG 600-D	DEG 600-P	WSJ 750-ET	Item No.
M27 Dustless Chuck	■									00315827
DCH 230 Depth Gauge		■								00212131
DCH 300 Depth Gauge			■							00212187
Angled Connector		■	■							00212190
5" Tuck Point Dust Hood					■					00284978
5" and 6" Cutting Dust Guard						■	■	■		00267720
5" and 6" Grinding Dust Guard						■	■	■		00267719
VC 20-U Vacuum Cleaner	■	■	■	■	■	■	■	■	■	00222428
VC 40-U Vacuum Cleaner	■	■	■	■	■	■	■	■	■	00218369
DD 110-D Dustless Kit – Includes tool, plastic kit box & dust extraction head with M27 chuck	■									03432816
DD 110-W Dustless Kit – Includes tool, dust removal adaptor, BI chuck, water swivel, 5/8-11 BT adaptor for slotted dry bits	■									03476075
DCH 300 Dustless Package – Includes tool, depth gauge, choice of 4 blades, VC 40-U vacuum, (10) plastic bags and kit box			■							03439182
5" Dust Control Grinding Package with VC 20-U – VC 20-U vacuum, choice of (1) 5" grinder: DEG 500-D or DCG 500-S, choice of (1) dust hood: DC-EX 125/5"C (cutting), DG-EX 125/5" (grinding) or DC-EX 125/5"M (cutting)					■					03450592
5" Dust Control Grinding Package with VC 40-U – VC 40-U vacuum, choice of (1) 5" grinder: DEG 500-D or DCG 500-S, choice of (1) dust hood: DC-EX 125/5"C (cutting), DG-EX 125/5" (grinding) or DC-EX 125/5"M (cutting)						■				03450783
DG 150 with VC 40-U – Includes tool, DPC 20, VC 40-U vacuum, rear handle & (10) plastic bags				■						03439309
DG 150 Deluxe – Includes tool, DPC 20, VC 40-U vacuum, rear handle, choice of 3 cup wheels & (10) plastic bags				■						03439310
DG 150 HEPA – Includes tool, DPC 20, VC 40-U vacuum, HEPA filter, (5) fleece bags and rear handle				■						03439311

Vacuum Accessories

Description	VC 20-U	VC 40-U	Qty	Item No.
Plastic Bag VC 20-U	■		10	00203854
Plastic Bag VC 40-U		■	10	00203852
Fleece Bags VC 20-U Required for HEPA use	■		5	00203859
Fleece Bags VC 40-U Required for HEPA use		■	5	00203857
Paper Dry Main Filter Replacement main filter for primarily dry use	■	■	1	00203862
Polyester Wet Main Filter Replacement main filter for primarily wet use	■	■	1	00203863
VC 20/40 HEPA Filter	■	■	1	00203879
Vacuum Hose 36 mm x 16' Antistatic Replacement hose for VC 20-U and VC 40-U for concrete and masonry applications	■	■	1	00203867
Vacuum Hose Adapter Fits VC 20-U and VC 40-U for use with various tools	■	■	1	00203878
Vacuum Accessory Set Includes: (2) extensions, (1) elbow, (1) floor nozzle, and (1) crevice tool	■	■	1	00203868
Rear Handle with DPC 20 Holder Rear handle for VC 40-U. Holds DPC 20 power conditioner for DG 150 and/or tool set		■	1	00203871

Hilti. Outperform. Outlast.

Hilti. Outperform. Outlast.

Hilti offers alternative, dust controlled working methods.

**Longer power tool lifetime.
Hilti DRS keeps your power tools fit - for longer.¹**

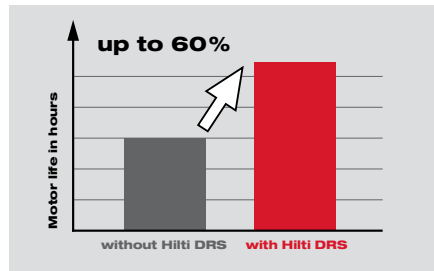

**Longer consumable lifetime.
Hilti DRS keeps your consumable fit - for longer.²**

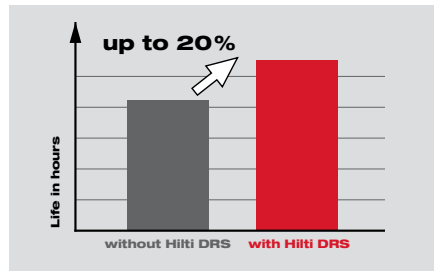

**Up to 99% less dust.
In your immediate working surroundings.³**

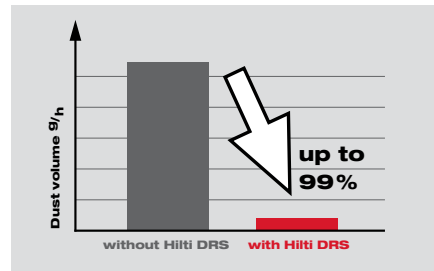

**Higher working speed.
Get the job done faster - with Hilti DRS.⁴**

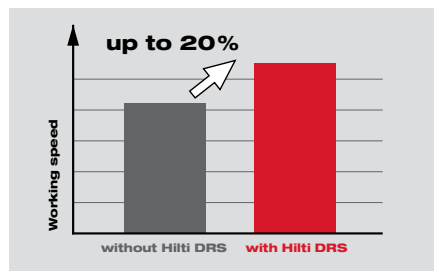

**Invest in Hilti DRS.
It simply pays off.⁵**

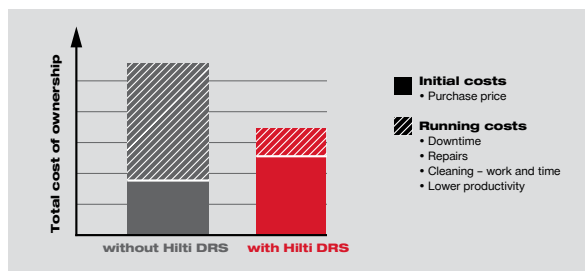

¹ Life-expectancy test with a Hilti DCH 230 cutter: The dust resistance of the carbon brushes was tested in a dust chamber. Without Hilti DRS, the carbon brushes had to be changed for the first time after approx. 85 hours. In comparison, in dustless conditions, the same power tool ran for approx. 140 hours in the same test chamber before the brushes needed changing for the first time. Please note: Tests conducted on a test rig are not always directly comparable with real-life conditions. Results may differ based on operator technique, specific application and tool combination.

² Life-expectancy test of disc with a Hilti DCH 230 cutter: Hyosung M1 111007 Light Duty, without and with dust extraction. 230 mm cutting disc performance, KSV Augsburg, system test (5600 rpm, 7 cm cutting depth). Please note: Tests conducted on a test rig are not always directly comparable with real-life conditions. Results may differ based on operator technique, specific application and tool combination.

³ Research project "Assessment of the dust emission characteristics of hand-held power tools and machines for working on mineral materials", by the Fachverband Elektrowerkzeuge (electric tools trade association) in cooperation with the Berufsgenossenschaft Bau, Deutschland (German statutory accident insurance for construction industry) (2006). Results may differ based on operator technique, specific application, and tool/accessory condition. The need for additional safeguards must be evaluated by the responsible health and safety personnel on site." Documentation: www.gisbau.de/service/sonstiges/staub/Abschlussbericht.pdf

⁴ Relative comparison with and without dust removal system, DCH 230, system test (5,600 rpm, 7 cm cutting depth, concrete KSV Augsburg) Please note: Tests conducted on a test rig are not always directly comparable with real-life conditions. Results may differ based on operator technique, specific application and tool combination

⁵ The data is based on a general assessment made under average conditions and may vary from case to case.

Services you can rely on. Your daily needs are our business.

**Let's talk about it.
How to achieve higher productivity
and greater safety on the jobsite.**

Tougher competition, tighter schedules, inexperienced personnel, new methods of working – the reasons for incidents, accidents, injury or serious health risks are manifold. The difficulties are added to by often regulations which can sometimes be challenging to observe. Hilti, as your partner, can help to clarify the available systems to help you comply, and provide practical training for your employees. Just contact us – we would be pleased to discuss this with you.



**Hilti Fleet Management
We manage your tools,
so you can manage your business.**

We look after your entire fleet of tools so you can concentrate on your own daily business. Together with you we analyze your existing fleet of tools so your new fleet includes only the tools you really need. With Hilti Fleet Management, a fixed monthly charge covers all tool, service and repair costs. That greatly simplifies your financial planning and takes a load of administrative work off your shoulders. It also ensures that you always work with the most advanced Hilti tools with respect to health and safety. Sounds attractive? Yes, it is – just ask your Hilti representative for more information.



**Hilti Lifetime Service.
Anything but business as usual.**

Hilti Lifetime Service applies to all Hilti power tools. We provide this outstanding service for the entire life of the product – completely free of charge for up to two years from date of purchase – covering repair or replacement of defective parts (even parts subject to wear and tear!) and including free pick-up and return transport and of course various safety checks to ensure fulfilment of various health and safety standards. After that, Hilti continues to prove the quality of its products by setting a repair cost limit – for the entire life of the product. That's not just reassuring to know, it's unique in this field. Some limitations apply. Contact Hilti for details.

HILTI	up to 2 Years
LIFETIME SERVICE	NO COSTS
Lifetime	Lifetime
REPAIR COST LIMIT	MANUFACTURER'S WARRANTY

Hilti. Outperform. Outlast.

Hilti. Outperform. Outlast.

Hilti. Outperform. Outlast.

P.O. Box 21148, Tulsa, OK 74121 • Hilti, Inc. (US) 1-800-879-8000 www.us.hilti.com • en español 1-800-879-5000 www.us.hilti.com/espanol
Hilti (Canada) Corporation 1-800-363-4458 www.hilti.ca • Hilti is an equal opportunity employer • Hilti is a registered trademark of Hilti, Corp.
©Copyright 2009 by Hilti, Inc. • H090 • 3456442 • 8/11 • BM

The data contained in this literature was current as of the date of publication. Updates and changes may be made based on later testing. If verification is needed that the data is still current, please contact the Hilti Technical Support Specialists at 1-800-879-8000. All published load values contained in this literature represent the results of testing by Hilti or test organizations. Local base materials were used. Because of variations in materials, on-site testing is necessary to determine performance at any specific site.
Printed in the United States

Certified Quality and
Environmental Systems



ISO 9001 / ISO 14001*
Reg. No. 12455-02

*ISO 14001 US Only