

ICC-ES Evaluation Report

ESR-3814

Reissued January 2025

This report also contains:

For references to other reports.

- [City of LA Supplement](#)

- See [ELC-3814](#) for Canadian Code

Subject to renewal January 2027

- [FL Supplement w/ HVHZ](#)

ICC-ES Evaluation Reports are not to be construed as representing aesthetics or any other attributes not specifically addressed, nor are they to be construed as an endorsement of the subject of the report or a recommendation for its use. There is no warranty by ICC Evaluation Service, LLC, express or implied, as to any finding or other matter in this report, or as to any product covered by the report.

Copyright © 2025 ICC Evaluation Service, LLC. All rights reserved.

<p>DIVISION: 03 00 00— CONCRETE</p> <p>Section: 03 16 00— Concrete Anchors</p> <p>DIVISION: 05 00 00— METALS</p> <p>Section: 05 05 19— Post-installed Concrete Anchors</p>	<p>REPORT HOLDER: HILTI, INC.</p>	<p>EVALUATION SUBJECT: HILTI HIT-RE 500 V3 ADHESIVE ANCHORS AND POST-INSTALLED REINFORCING BAR CONNECTIONS IN CRACKED AND UNCRACKED CONCRETE</p>	
--	---	--	---

1.0 EVALUATION SCOPE

Compliance with the following codes:

- 2021, 2018, 2015, and 2012 [International Building Code® \(IBC\)](#)
- 2021, 2018, 2015, and 2012 [International Residential Code® \(IRC\)](#)

Property evaluated:

- Structural

2.0 USES

The Hilti HIT-RE 500 V3 Adhesive Anchoring System and Post-Installed Reinforcing Bar System are used to resist static, wind and earthquake (Seismic Design Categories A through F) tension and shear loads in cracked and uncracked normal-weight and lightweight concrete having a specified compressive strength, f'_c , of 2,500 psi to 8,500 psi (17.2 MPa to 58.6 MPa).

The anchor system complies with anchors as described in Section 1901.3 of the 2021, 2018 and 2015 IBC, and Section 1909 of the 2012 IBC and is an alternative to cast-in-place anchors described in Section 1908 of the 2012 IBC. The anchor systems may also be used where an engineered design is submitted in accordance with Section R301.1.3 of the IRC.

The post-installed reinforcing bar system is an alternative to cast-in-place reinforcing bars governed by ACI 318 and IBC Chapter 19.

3.0 DESCRIPTION

3.1 General:

The Hilti HIT-RE 500 V3 Adhesive Anchoring System and Post-Installed Reinforcing Bar System are comprised of the following components:

- Hilti HIT-RE 500 V3 adhesive packaged in foil packs
- Adhesive mixing and dispensing equipment
- Equipment for hole cleaning and adhesive injection

The Hilti HIT-RE 500 V3 Adhesive Anchoring System may be used with continuously threaded rod, Hilti HIS-(R)N internally threaded inserts or deformed steel reinforcing bars as depicted in Figure 4. The Hilti HIT-RE 500 V3 Post-Installed Reinforcing Bar System may only be used with deformed steel reinforcing bars as depicted in Figures 2 and 3. The primary components of the Hilti Adhesive Anchoring and Post-Installed Reinforcing Bar Systems, including the Hilti HIT-RE 500 V3 Adhesive, HIT-RE-M static mixing nozzle and steel anchoring elements, are shown in Figure 7 of this report.

The manufacturer's printed Installation instructions (MPII), as included with each adhesive unit package, are consolidated as Figure 8A and 8B.

3.2 Materials:

3.2.1 Hilti HIT-RE 500 V3 Adhesive: Hilti HIT-RE 500 V3 Adhesive is an injectable, two-component epoxy adhesive. The two components are separated by means of a dual-cylinder foil pack attached to a manifold. The two components combine and react when dispensed through a static mixing nozzle attached to the manifold. Hilti HIT-RE 500 V3 is available in 11.1-ounce (330 ml), 16.9-ounce (500 ml), and 47.3-ounce (1400 ml) foil packs. The manifold attached to each foil pack is stamped with the adhesive expiration date. The shelf life, as indicated by the expiration date, applies to an unopened foil pack stored in a dry, dark environment and in accordance with Figure 8A.

3.2.2 Hole Cleaning Equipment:

3.2.2.1 Standard Equipment: Standard hole cleaning equipment, comprised of steel wire brushes and air nozzles, is described in Figure 8A of this report.

3.2.2.2 Hilti Safe-Set™ System: For the elements described in Sections 3.2.5.1 through 3.2.5.3 and Section 3.2.6, the Hilti TE-CD or TE-YD hollow carbide drill bit with a carbide drilling head conforming to ANSI B212.15 must be used. When used in conjunction with a Hilti vacuum with a minimum value for the maximum volumetric flow rate of 129 CFM (61 l/s), the Hilti TE-CD or TE-YD drill bit will remove the drilling dust, automatically cleaning the hole. Available sizes for Hilti TE-CD or TE-YD drill bit are shown in Figure 8A.

3.2.3 Hole Preparation Equipment:

3.2.3.1 Hilti Safe-Set™ System: TE-YRT Roughening Tool: For the elements described in Sections 3.2.5.1 through 3.2.5.3 and [Tables 9, 12, 17, 20](#), and [29](#), the Hilti TE-YRT roughening tool with a carbide roughening head is used for hole preparation in conjunction with holes core drilled with a diamond core bit as illustrated in Figure 5.

3.2.4 Dispensers: Hilti HIT-RE 500 V3 must be dispensed with manual, electric, or pneumatic dispensers provided by Hilti.

3.2.5 Anchor Elements:

3.2.5.1 Threaded Steel Rods: Threaded steel rods must be clean, continuously threaded rods (all-thread) in diameters as described in [Tables 6](#) and [14](#) and Figure 4 of this report. Steel design information for common grades of threaded rods is provided in [Table 2](#). Carbon steel threaded rods must be furnished with a 0.0002-inch-thick (0.005 mm) zinc electroplated coating complying with ASTM B633 SC 1 or must be hot-dipped galvanized complying with ASTM A153, Class C or D. Stainless steel threaded rods must comply with ASTM F593 or ISO 3506 A4. Threaded steel rods must be straight and free of indentations or other defects along their length. The ends may be stamped with identifying marks and the embedded end may be blunt cut or cut on the bias to a chisel point.

3.2.5.2 Steel Reinforcing Bars for use in Post-Installed Anchor Applications: Steel reinforcing bars are deformed bars as described in [Table 3](#) of this report. [Tables 6, 14](#), and [22](#) and Figure 4 summarize reinforcing bar size ranges. The embedded portions of reinforcing bars must be straight, and free of mill scale, rust, mud, oil, and other coatings (other than zinc) that may impair the bond with the adhesive. Reinforcing bars must not be bent after installation, except as set forth in ACI 318-19 Section 26.6.3.2(b), ACI 318-14 Section 26.6.3.1(b) or ACI 318-11 Section 7.3.2, as applicable, with the additional condition that the bars must be bent cold, and heating of reinforcing bars to facilitate field bending is not permitted.

3.2.5.3 Hilti HIS-N and HIS-RN Inserts: Hilti HIS-N and HIS-RN inserts have a profile on the external surface and are internally threaded. Mechanical properties for Hilti HIS-N and HIS-RN inserts are provided in [Table 4](#). The inserts are available in diameters and lengths as shown in [Table 26](#) and Figure 4. Hilti HIS-N inserts are produced from carbon steel and furnished with a 0.0002-inch-thick (0.005 mm) zinc electroplated coating complying with ASTM B633 SC 1. The stainless steel Hilti HIS-RN inserts are fabricated from X5CrNiMo17122 K700 steel conforming to DIN 17440. Specifications for common bolt types that may be used in conjunction with Hilti HIS-N and HIS-RN inserts are provided in [Table 5](#). Bolt grade and material type (carbon, stainless) must be matched to the insert. Strength reduction factors, ϕ , corresponding to brittle steel elements must be used for Hilti HIS-N and HIS-RN inserts.

3.2.5.4 Ductility: In accordance with ACI 318 (-19 and -14) 2.3 or ACI 318-11 D.1, as applicable, in order for a steel element to be considered ductile, the tested elongation must be at least 14 percent and reduction of area must be at least 30 percent. Steel elements with a tested elongation of less than 14 percent or a reduction of area of less than 30 percent, or both, are considered brittle. Values for various steel materials are provided in [Tables 2, 3, 4, and 5](#) of this report. Where values are nonconforming or unstated, the steel must be considered brittle.

3.2.6 Steel Reinforcing Bars for Use in Post-Installed Reinforcing Bar Connections: Steel reinforcing bars used in post-installed reinforcing bar connections are deformed bars (rebar) as depicted in Figures 2 and 3. [Tables 31, 32, 33](#), and Figure 4 summarize reinforcing bar size ranges. The embedded portions of reinforcing bars must be straight, and free of mill scale, rust, mud, oil, and other coatings that may impair the bond with the adhesive. Reinforcing bars must not be bent after installation, except as set forth in Section 26.6.3.2(b) of ACI 318-19, ACI 318-14 26.6.3.1(b) or ACI 318-11 7.3.2, as applicable, with the additional condition that the bars must be bent cold, and heating of reinforcing bars to facilitate field bending is not permitted.

3.3 Concrete:

Normal-weight or lightweight concrete must comply with Sections 1903 and 1905 of the IBC, as applicable. The specified compressive strength of the concrete must be from 2,500 psi to 8,500 psi (17.2 MPa to 58.6 MPa).

4.0 DESIGN AND INSTALLATION

4.1 Strength Design of Post-Installed Anchors:

Refer to [Table 1](#) for the design parameters for specific installed elements, and refer to Figure 5 and Section 4.1.4 for a flowchart to determine the applicable design bond strength or pullout strength.

4.1.1 General: The design strength of anchors under the 2021 IBC, as well as the 2021 IRC, must be determined in accordance with ACI 318-19 and this report. The design strength of anchors complying with the 2018 and 2015 IBC, as well as Section R301.1.3 of the 2018 and 2015 IRC must be determined in accordance with ACI 318-14 Chapter 17 and this report.

The design strength of anchors under the 2012 IBC, as well as the 2012 IRC must be determined in accordance with ACI 318-11 and this report.

Design parameters are based on ACI 318-19 for use with the 2021 IBC, ACI 318-14 for use with the 2018 and 2015 IBC, and ACI 318-11 for use with the 2012 IBC unless noted otherwise in Sections 4.1.1 through 4.1.11 of this report.

The strength design of anchors must comply with ACI 318-19 17.5.1.2, ACI 318-14 17.3.1 or ACI 318-11 D.4.1 as applicable, except as required in ACI 318-19 17.10, ACI 318-14 17.2.3 or ACI 318-11 D.3.3, as applicable.

Design parameters are provided in [Table 6A](#) through [Table 30](#). Strength reduction factors, ϕ , as given in ACI 318-19 17.5.3, ACI 318-14 17.3.3 or ACI 318-11 D.4.3, as applicable, must be used for load combinations calculated in accordance with Section 1605.1 of the 2021 IBC, Section 1605.2 of the 2018, 2015, and 2012 IBC or ACI 318 (-19 and -14) 5.3 or ACI 318-11 9.2, as applicable. Strength reduction factors, λ , as given in ACI 318-11 D.4.4 must be used for load combinations calculated in accordance with ACI 318-11 Appendix C.

4.1.2 Static Steel Strength in Tension: The nominal static steel strength of a single anchor in tension, N_{sa} , in accordance with ACI 318-19 17.6.1.2, ACI 318-14 17.4.1.2 or ACI 318-11 Section D.5.1.2, as applicable, and the associated strength reduction factors, λ , in accordance with ACI 318-19 17.5.3, ACI 318-14 17.3.3 or ACI 318-11 Section D.4.3, as applicable, are provided in the tables outlined in [Table 1](#) for the anchor element types included in this report.

4.1.3 Static Concrete Breakout Strength in Tension: The nominal concrete breakout strength of a single anchor or group of anchors in tension, N_{cb} or N_{cbg} , must be calculated in accordance with ACI 318-19 17.6.2, ACI 318-14 17.4.2 or ACI 318-11 D.5.2, as applicable, with the following addition:

The basic concrete breakout strength of a single anchor in tension, N_b , must be calculated in accordance with ACI 318-19 17.6.2.2, ACI 318-14 17.4.2.2 or ACI 318-11 D.5.2.2, as applicable using the values of $K_{c,cr}$, and $K_{c,uncr}$, as described in this report. Where analysis indicates no cracking in accordance with ACI 318-19 17.6.2.5, ACI 318-14 17.4.2.6 or ACI 318-11 D.5.2.6, as applicable, N_b must be calculated using $K_{c,uncr}$ and $\Psi_{c,N} = 1.0$. See [Table 1](#). For anchors in lightweight concrete, see ACI 318-19 17.2.4, ACI 318-14 17.2.6 or ACI 318-11 D.3.6, as applicable. The value of f'_c used for calculation must be limited to 8,000 psi (55 MPa) in accordance with ACI 318-19 17.3.1, ACI 318-14 17.2.7 or ACI 318-11 D.3.7, as applicable. Additional information for the determination of nominal bond strength in tension is given in Section 4.1.4 of this report.

4.1.4 Static Bond Strength in Tension: The nominal static bond strength of a single adhesive anchor or group of adhesive anchors in tension, N_a or N_{ag} , must be calculated in accordance with ACI 318-19 17.6.5, ACI 318-14 17.4.5 or ACI 318-11 D.5.5, as applicable. Bond strength values are a function of the concrete compressive strength, whether the concrete is cracked or uncracked, the concrete temperature range, the drilling method, and the installation conditions (dry or water-saturated, etc.). The resulting characteristic bond strength shall be multiplied by the associated strength reduction factor ϕ_{nn} as follows:

DRILLING METHOD	CONCRETE TYPE	PERMISSIBLE INSTALLATION CONDITIONS	BOND STRENGTH	ASSOCIATED STRENGTH REDUCTION FACTOR
Hammer-drill	Cracked and Uncracked	Dry	$\phi_{k,uncr}$ OR $\phi_{k,cr}$	ϕ_d
		Water-saturated	$\phi_{k,uncr}$ OR $\phi_{k,cr}$	ϕ_{ws}
		Water-filled hole	$\phi_{k,uncr}$ OR $\phi_{k,cr}$	ϕ_{wf}
		Underwater application	$\phi_{k,uncr}$ OR $\phi_{k,cr}$	ϕ_{uw}
Core Drilled with Roughening Tool or Hilti TE-CD or TE-YD Hollow Drill Bit	Cracked and Uncracked	Dry	$\phi_{k,uncr}$ OR $\phi_{k,cr}$	ϕ_d
		Water-saturated	$\phi_{k,uncr}$ OR $\phi_{k,cr}$	ϕ_{ws}
Core Drilled	Uncracked	Dry	$\phi_{k,uncr}$	ϕ_d
		Water-saturated	$\phi_{k,uncr}$	ϕ_{ws}

Figure 5 of this report presents a bond strength design selection flowchart. Strength reduction factors for determination of the bond strength are outlined in Table 1 of this report. Adjustments to the bond strength may also be made for increased concrete compressive strength as noted in the footnotes to the bond strength tables.

4.1.5 Static Steel Strength in Shear: The nominal static strength of a single anchor in shear as governed by the steel, V_{sa} , in accordance with ACI 318-19 17.7.1.2, ACI 318-14 17.5.1.2 or ACI 318-11 D.6.1.2, as applicable, and strength reduction factors, ϕ , in accordance with ACI 318-19 17.5.3, ACI 318-14 17.3.3 or ACI 318-11 D.4.3, as applicable, are given in the tables outlined in Table 1 for the anchor element types included in this report.

4.1.6 Static Concrete Breakout Strength in Shear: The nominal static concrete breakout strength of a single anchor or group of anchors in shear, V_{cb} or V_{cbg} , must be calculated in accordance with ACI 318-19 17.7.2, ACI 318-14 17.5.2 or ACI 318-11 D.6.2, as applicable, based on information given in the tables outlined in Table 1. The basic concrete breakout strength of a single anchor in shear, V_b , must be calculated in accordance with ACI 318-19 17.7.2.2, ACI 318-14 17.5.2.2 or ACI 318-11 D.6.2.2, as applicable, using the values of d given in the tables as outlined in Table 1 for the corresponding anchor steel in lieu of d_a (2021, 2018, 2015, and 2012 IBC). In addition, h_{ef} must be substituted for ℓ_e . In no case must ℓ_e exceed $8d$. The value of f'_c must be limited to a maximum of 8,000 psi (55 MPa) in accordance with ACI 318-19 17.3.1, ACI 318-14 17.2.7 or ACI 318-11 D.3.7, as applicable.

4.1.7 Static Concrete Pryout Strength in Shear: The nominal static pryout strength of a single anchor or group of anchors in shear, V_{cp} or V_{cpg} , must be calculated in accordance with ACI 318-19 17.7.3, ACI 318-14 17.5.3 or ACI 318-11 D.6.3, as applicable.

4.1.8 Interaction of Tensile and Shear Forces: For designs that include combined tension and shear, the interaction of tension and shear loads must be calculated in accordance with ACI 318-19 17.8, ACI 318-14 17.6 or ACI 318-11 D.7, as applicable.

4.1.9 Minimum Member Thickness, h_{min} , Anchor Spacing, s_{min} and Edge Distance, c_{min} : In lieu of ACI 318-19 17.9.2, ACI 318-14 17.7.1 and 17.7.3 or ACI 318-11 D.8.1 and D.8.3, as applicable, values of s_{min} and c_{min} described in this report must be observed for anchor design and installation. Likewise, in lieu of ACI 318-19 17.9.4, ACI 318-14 17.7.5 or ACI 318-11 D.8.5, as applicable, the minimum member thicknesses, h_{min} , described in this report must be observed for anchor design and installation. For adhesive anchors that will remain untorqued, ACI 318-19 17.9.3, ACI 318-14 17.7.4 or ACI 318-11 D.8.4, as applicable, applies.

For edge distances c_{ai} and anchor spacing s_{ai} , the maximum torque T_{max} shall comply with the following requirements:

REDUCED MAXIMUM INSTALLATION TORQUE $T_{max,red}$ FOR EDGE DISTANCES $c_{ai} < (5 \times d_a)$		
EDGE DISTANCE, c_{ai}	MINIMUM ANCHOR SPACING, s_{ai}	MAXIMUM TORQUE, $T_{max,red}$
$1.75 \text{ in. (45 mm)} \leq c_{ai} < 5 \times d_a$	$5 \times d_a \leq s_{ai} < 16 \text{ in.}$	$0.3 \times T_{max}$
	$s_{ai} \geq 16 \text{ in. (406 mm)}$	$0.5 \times T_{max}$

4.1.10 Critical Edge Distance c_{ac} : In lieu of ACI 318-19 17.9.5, ACI 318-14 17.7.6 or ACI 318-11 D.8.6, as applicable, c_{ac} must be determined as follows:

$$c_{ac} = h_{ef} \cdot \left(\frac{\tau_{k,uncr}}{1160} \right)^{0.4} \cdot \left[3.1 - 0.7 \frac{h}{h_{ef}} \right] \quad \text{Eq. (4-1)}$$

where $\left[\frac{h}{h_{ef}} \right]$ need not be taken as larger than 2.4: and

$\tau_{k,uncr}$ is the characteristic bond strength in uncracked concrete stated in the tables of this report, whereby $\tau_{k,uncr}$ need not be taken as greater than:

$$\tau_{k,uncr} = \frac{k_{uncr} \sqrt{h_{ef} f'_c}}{\pi \cdot d_a}$$

4.1.11 Design Strength in Seismic Design Categories C, D, E and F: In structures assigned to Seismic Design Category C, D, E or F under the IBC or IRC, the design must be performed according to ACI 318-19 17.10, ACI 318-14 17.2.3 or ACI 318-11 Section D.3.3, as applicable. Modifications to ACI 318-19 17.10 and ACI 318-14 17.2.3 shall be applied under Section 1905.1.8 of the 2021, 2018 and 2015 IBC. For the 2012 IBC, Section 1905.1.9 shall be omitted.

The nominal steel shear strength, V_{sa} , must be adjusted by $\alpha_{V,seis}$ as given in the tables summarized in [Table 1](#) for the anchor element types included in this report. For tension, the nominal pullout strength $N_{p,cr}$ or bond strength τ_{cr} must be adjusted by $\alpha_{N,seis}$. See [Tables 8, 9, 11, 12, 16, 17, 19, 20, 24, 28](#) and [29](#).

Modify ACI 318-11 Sections D.3.3.4.2, D.3.3.4.3(d) and D.3.3.5.2 to read as follows:

ACI 318-11 D.3.3.4.2 - Where the tensile component of the strength-level earthquake force applied to anchors exceeds 20 percent of the total factored anchor tensile force associated with the same load combination, anchors and their attachments shall be designed in accordance with ACI 318-11 D.3.3.4.3. The anchor design tensile strength shall be determined in accordance with ACI 318-11 D.3.3.4.4

Exception:

1. *Anchors designed to resist wall out-of-plane forces with design strengths equal to or greater than the force determined in accordance with ASCE 7 Equation 12.11-1 or 12.14-10 shall be deemed to satisfy ACI 318-11 D.3.3.4.3(d).*

ACI 318-11 D.3.3.4.3(d) – The anchor or group of anchors shall be designed for the maximum tension obtained from design load combinations that include E, with E increased by Ω_0 . The anchor design tensile strength shall be calculated from ACI 318-11 D.3.3.4.4.

ACI 318-11 D.3.3.5.2 – Where the shear component of the strength-level earthquake force applied to anchors exceeds 20 percent of the total factored anchor shear force associated with the same load combination, anchors and their attachments shall be designed in accordance with ACI 318-11 D.3.3.5.3. The anchor design shear strength for resisting earthquake forces shall be determined in accordance with ACI 318-11 D.6.

Exceptions:

1. *For the calculation of the in-plane shear strength of anchor bolts attaching wood sill plates of bearing or non-bearing walls of light-frame wood structures to foundations or foundation stem walls, the in-plane shear strength in accordance with ACI 318-11 D.6.2 and D.6.3 need not be computed and ACI 318-11 D.3.3.5.3 need not apply provided all of the following are satisfied:*

- 1.1. *The allowable in-plane shear strength of the anchor is determined in accordance with AF&PA NDS Table 11E for lateral design values parallel to grain.*
- 1.2. *The maximum anchor nominal diameter is $\frac{5}{8}$ inch (16 mm).*
- 1.3. *Anchor bolts are embedded into concrete a minimum of 7 inches (178 mm).*
- 1.4. *Anchor bolts are located a minimum of $1\frac{3}{4}$ inches (45 mm) from the edge of the concrete parallel to the length of the wood sill plate.*
- 1.5. *Anchor bolts are located a minimum of 15 anchor diameters from the edge of the concrete perpendicular to the length of the wood sill plate.*
- 1.6. *The sill plate is 2-inch or 3-inch nominal thickness.*

2. *For the calculation of the in-plane shear strength of anchor bolts attaching cold-formed steel track of bearing or non-bearing walls of light-frame construction to foundations or foundation stem walls, the in-plane shear strength in accordance with ACI 318-11 D.6.2 and D.6.3, need not be computed and ACI 318-11 D.3.3.5.3 need not apply provided all of the following are satisfied:*

- 2.1. The maximum anchor nominal diameter is $5/8$ inch (16 mm).
- 2.2. Anchors are embedded into concrete a minimum of 7 inches (178 mm).
- 2.3. Anchors are located a minimum of $1\ 3/4$ inches (45 mm) from the edge of the concrete parallel to the length of the track.
- 2.4. Anchors are located a minimum of 15 anchor diameters from the edge of the concrete perpendicular to the length of the track.
- 2.5. The track is 33 to 68 mil designation thickness.

Allowable in-plane shear strength of exempt anchors, parallel to the edge of concrete shall be permitted to be determined in accordance with AISI S100 Section E3.3.1.

3. In light-frame construction, bearing or nonbearing walls, shear strength of concrete anchors less than or equal to 1 inch [25 mm] in diameter attaching a sill plate or track to foundation or foundation stem wall need not satisfy ACI 318-11 D.3.3.5.3(a) through (c) when the design strength of the anchors is determined in accordance with ACI318-11 D.6.2.1(c).

4.2 Strength Design of Post-Installed Reinforcing Bars:

4.2.1 General: The design of straight post-installed deformed reinforcing bars must be determined in accordance with ACI 318 rules for cast-in place reinforcing bar development and splices and this report.

Examples of typical applications for the use of post-installed reinforcing bars are illustrated in Figures 2 and 3 of this report.

4.2.2 Determination of bar development length l_d : Values of l_d must be determined in accordance with the ACI 318 development and splice length requirements for straight cast-in place reinforcing bars.

Exceptions:

1. For uncoated and zinc-coated (galvanized) post-installed reinforcing bars, the factor Ψ_e shall be taken as 1.0. For all other cases, the requirements in ACI 318-19 25.4.2.5, ACI 318-14 25.4.2.4 or ACI 318-11 12.2.4 (b) shall apply.
2. When using alternate methods to calculate the development length (e.g., anchor theory), the applicable factors for post-installed anchors generally apply.

4.2.3 Minimum Member Thickness, h_{min} , Minimum Concrete Cover, $c_{c,min}$, Minimum Concrete Edge Distance, $c_{b,min}$, Minimum Spacing, $s_{b,min}$: For post-installed reinforcing bars, there is no limit on the minimum member thickness. In general, all requirements on concrete

cover and spacing applicable to straight cast-in bars designed in accordance with ACI 318 shall be maintained.

For post-installed reinforcing bars installed at embedment depths, h_{ef} , larger than $20d$ ($h_{ef} > 20d$), the minimum concrete cover shall be as follows:

REBAR SIZE	MINIMUM CONCRETE COVER, $c_{c,min}$
$d_b \leq \text{No. 6 (16 mm)}$	$1\ 3/16 \text{ in. (30mm)}$
$\text{No. 6} < d_b \leq \text{No. 10}$ ($16\text{mm} < d_b \leq 32\text{mm}$)	$1\ 9/16 \text{ in. (40mm)}$

The following requirements apply for minimum concrete edge and spacing for $h_{ef} > 20d$:

Required minimum edge distance for post-installed reinforcing bars (measured from the center of the bar):

$$c_{b,min} = d_o/2 + c_{c,min}$$

Required minimum center-to-center spacing between post-installed bars:

$$s_{b,min} = d_o + c_{c,min}$$

Required minimum center-to-center spacing from existing (parallel) reinforcing:

$$s_{b,min} = d_b/2 \text{ (existing reinforcing)} + d_o/2 + c_{c,min}$$

All other requirements applicable to straight cast-in place bars designed in accordance with ACI 318 shall be maintained.

4.2.4 Design Strength in Seismic Design Categories C, D, E and F: In structures assigned to Seismic Category C, D, E or F under the IBC or IRC, design of straight post-installed reinforcing bars must take into account the provisions of ACI 318 (-19 or -14) Chapter 18 or ACI 318-11 Chapter 21, as applicable.

4.2.5 Design in Fire Resistive Construction: For post-installed reinforcing bars, the relationship of bond stress to temperature under fire conditions for short term loading (including seismic), suitable for use in determining conformance with fire resistance rating requirements is as follows (see Figures 6A and 6B):

$$\tau_{fire(\theta)} = 1,137,318 \cdot \theta^{-1.47} \quad (\text{psi})$$

$$\tau_{fire(\theta)} = 522.93 \cdot \theta^{-1.14} \quad (\text{N/mm}^2)$$

Where θ is the temperature in the concrete at the post-installed reinforcing bar in °F (for psi) or °C (for N/mm²), as applicable.

For temperatures above θ_{max} of 581 °F (305 °C), $\tau_{fire(\theta)}=0$. For load cases including sustained loads, with or without short term loading, multiply $\tau_{fire(\theta)}$ by 0.93.

The bond stress, $\tau_{fire(\theta)}$, shall not exceed 1,090 psi (7.5 N/mm²).

Determination of the temperature in the concrete at the location of the post-installed reinforcing bar is dependent on the geometry of the concrete members under consideration, and its calculation is the responsibility of the design professional. The design professional shall use the bond strength / temperature curves in Figure 6 along with a determination of the temperature in the concrete appropriate for the member geometry under consideration to calculate the reinforcing bar development length l_d .

4.3 Installation:

Installation parameters are illustrated in Figures 1 and 4. Installation must be in accordance with ACI 318-19 26.7.2, ACI 318-14 17.8.1 and 17.8.2 or ACI 318-11 D.9.1 and D.9.2, as applicable. Anchor and post-installed reinforcing bar locations must comply with this report and the plans and specifications approved by the code official. Installation of the Hilti HIT-RE 500 V3 Adhesive Anchor and Post-Installed Reinforcing Bar Systems must conform to the manufacturer's printed installation instructions (MPII) included in each unit package consolidated as Figures 8A and 8B of this report. The MPII contains additional requirements for combinations of drill hole depth, diameter, drill bit type, hole preparation, and dispensing tools.

The initial cure time, $t_{cure,ini}$, as noted in Figure 8A of this report, is intended for rebar applications only and is the time where rebar and concrete formwork preparation may continue. Between the initial cure time and the full cure time, $t_{cure,final}$, the adhesive has a limited load bearing capacity. Do not apply a torque or load on the rebar during this time

4.4 Special Inspection:

Periodic special inspection must be performed where required in accordance with Section 1705.1.1 and Table 1705.3 of the 2021, 2018, 2015 and 2012 IBC, as applicable, and this report. The special inspector must be on the jobsite initially during anchor or post-installed reinforcing bar installation to verify anchor or post-installed reinforcing bar type and dimensions, concrete type, concrete compressive strength, adhesive identification and expiration date, hole dimensions, hole cleaning procedures, spacing, edge distances, concrete thickness, anchor or post-installed reinforcing bar embedment, tightening torque and adherence to the manufacturer's printed installation instructions.

The special inspector must verify the initial installations of each type and size of adhesive anchor or post-installed reinforcing bar by construction personnel on site. Subsequent installations of the same anchor or post-installed reinforcing bar type and size by the same construction personnel are permitted to be performed in the absence of the special inspector. Any change in the anchor or post-installed reinforcing bar product being installed or the personnel performing the installation requires an initial inspection. For ongoing installations over an extended period, the special inspector must make regular inspections to confirm correct handling and installation of the product.

Continuous special inspection of adhesive anchors or post-installed reinforcing bar installed in horizontal or upwardly inclined orientations to resist sustained tension loads shall be performed in accordance with ACI 318-19 26.13.3.2(e) and 26.7.1(j), ACI 318-14 17.8.2.4, 26.7.1(h), and 26.13.3.2(c) or ACI 318-11 D.9.2.4, as applicable.

Under the IBC, additional requirements as set forth in Sections 1705, 1706, and 1707 must be observed, where applicable.

5.0 CONDITIONS OF USE:

The Hilti HIT-RE 500 V3 Adhesive Anchor System and Post-Installed Reinforcing Bar System described in this report complies with, or is a suitable alternative to what is specified in, the codes listed in Section 1.0 of this report, subject to the following conditions:

- 5.1 Hilti HIT-RE 500 V3 Adhesive anchors and post-installed reinforcing bars must be installed in accordance with the manufacturer's printed installation instructions (MPII) as included in the adhesive packaging and consolidated as Figures 8A and 8B of this report.
- 5.2 The anchors and post-installed reinforcing bars must be installed in cracked and uncracked normal-weight concrete having a specified compressive strength $f'_c = 2,500$ psi to 8,500 psi (17.2 MPa to 58.6 MPa).
- 5.3 The values of f'_c used for calculation purposes must not exceed 8,000 psi (55.1 MPa).
- 5.4 The concrete shall have attained its minimum design strength prior to installation of the Hilti HIT-RE 500 V3 adhesive anchors or post-installed reinforcing bars.
- 5.5 Anchors and post-installed reinforcing bars must be installed in concrete base materials in holes drilled using carbide-tipped drill bits manufactured with the range of maximum and minimum drill-tip dimensions specified in ANSI B212.15-1994, or diamond core drill bits, as detailed in Figure 8A. Use of the Hilti TE-YRT Roughening Tool in conjunction with diamond core bits must be as detailed in Figure 8B.
- 5.6 Loads applied to the anchors must be adjusted in accordance with Section 1605.1 of the 2021 IBC or Section 1605.2 of the 2018, 2015 and 2012 IBC for strength design and in accordance with Section 1605.1 of the 2021 IBC or Section 1605.3 of the 2018, 2015, and 2012 IBC for allowable stress design.
- 5.7 Hilti HIT-RE 500 V3 adhesive anchors and post-installed reinforcing bars are recognized for use to resist short- and long-term loads, including wind and earthquake, subject to the conditions of this report.
- 5.8 In structures assigned to Seismic Design Category C, D, E or F under the IBC or IRC, anchor strength must be adjusted in accordance with Section 4.1.11 of this report, and post-installed reinforcing bars must comply with section 4.2.4 of this report.
- 5.9 Hilti HIT-RE 500 V3 adhesive anchors and post-installed reinforcing bars are permitted to be installed in concrete that is cracked or that may be expected to crack during the service life of the anchor, subject to the conditions of this report.
- 5.10 Anchor strength design values must be established in accordance with Section 4.1 of this report.
- 5.11 Post-installed reinforcing bar development and splice length is established in accordance with Section 4.2 of this report.
- 5.12 Minimum anchor spacing and edge distance as well as minimum member thickness must comply with the values noted in this report.
- 5.13 Post-installed reinforcing bar spacing, minimum member thickness, and cover distance must be in accordance with the provisions of ACI 318 for cast-in place bars and section 4.2.3 of this report.
- 5.14 Prior to anchor installation, calculations and details demonstrating compliance with this report must be submitted to the code official. The calculations and details must be prepared by a registered design professional where required by the statutes of the jurisdiction in which the project is to be constructed.
- 5.15 Anchors and post-installed reinforcing bars are not permitted to support fire-resistive construction. Where not otherwise prohibited by the code, Hilti HIT-RE 500 V3 adhesive anchors and post-installed reinforcing bars are permitted for installation in fire-resistive construction provided that at least one of the following conditions is fulfilled:
 - Anchors and post-installed reinforcing bars are used to resist wind or seismic forces only.
 - Anchors and post-installed reinforcing bars that support gravity load-bearing structural elements are within a fire-resistive envelope or a fire-resistive membrane, are protected by approved fire-resistive materials, or have been evaluated for resistance to fire exposure in accordance with recognized standards.
 - Anchors and post-installed reinforcing bars are used to support nonstructural elements.
 - Post-installed reinforcing bars designed in accordance with Section 4.2.5 of this report.
- 5.16 Since an ICC-ES acceptance criteria for evaluating data to determine the performance of adhesive anchors and post-installed reinforcing bars subjected to fatigue or shock loading is unavailable at this time, the use of these anchors under such conditions is beyond the scope of this report.
- 5.17 Use of zinc-plated carbon steel threaded rods or steel reinforcing bars is limited to dry, interior locations.
- 5.18 Use of hot-dipped galvanized carbon steel and stainless steel rods is permitted for exterior exposure or damp environments.
- 5.19 Steel anchoring materials in contact with preservative-treated and fire-retardant-treated wood must be of zinc-coated carbon steel or stainless steel. The minimum coating weights for zinc-coated steel must comply

with ASTM A153. Periodic special inspection must be provided in accordance with Section 4.4 of this report. Continuous special inspection for anchors and post-installed reinforcing bars installed in horizontal or upwardly inclined orientations to resist sustained tension loads must be provided in accordance with Section 4.4 of this report.

- 5.20** Installation of anchors and post-installed reinforcing bars in horizontal or upwardly inclined orientations to resist sustained tension loads shall be performed by personnel certified by an applicable certification program in accordance with ACI 318-19 26.7.2(e), ACI 318-14 17.8.2.2 or 17.8.2.3, or ACI 318-11 D.9.2.2 or D.9.2.3, as applicable.
- 5.21** Hilti HIT-RE 500 V3 adhesive anchors and post-installed reinforcing bars may be used to resist tension and shear forces in floor, wall, and overhead installations only if installation is into concrete with a temperature between 23°F and 104°F (-5°C and 40°C) for threaded rods, rebar, and Hilti HIS-(R)N inserts. Overhead installations for hole diameters larger than 7/16-inch or 10mm require the use of piston plugs (HIT-SZ, -IP) during injection to the back of the hole. 7/16-inch or 10mm diameter holes may be injected directly to the back of the hole with the use of extension tubing on the end of the nozzle. The anchor or post-installed reinforcing bars must be supported until fully cured (i.e., with Hilti HIT-OHW wedges, or other suitable means). Where temporary restraint devices are used, their use shall not result in impairment of the anchor shear resistance. Installations in concrete temperatures below 41°F (5°C) require the adhesive to be conditioned to a minimum temperature of 41°F (5°C).
- 5.22** Anchors and post-installed reinforcing bars shall not be used for applications where the concrete temperature can rise from 40°F or less to 80°F or higher within a 12-hour period. Such applications may include but are not limited to anchorage of building façade systems and other applications subject to direct sun exposure.
- 5.23** Hilti HIT-RE 500 V3 adhesives are manufactured by Hilti GmbH, Kaufering, Germany, under a quality-control program with inspections by ICC-ES.
- 5.24** Hilti HIS-N and HIS-RN inserts are manufactured by Hilti (China) Ltd., Guangdong, China, under a quality-control program with inspections by ICC-ES.

6.0 EVIDENCE SUBMITTED

Data in accordance with the [ICC-ES Acceptance Criteria for Post-installed Adhesive Anchors and Reinforcing Bars in Concrete Elements \(AC308\)](#), dated October 2022, which incorporates requirements in ACI 355.4 (-19 and -11), including but not limited to tests under freeze/thaw conditions (Table 3.2, test series 6), and Table 3.8 for evaluating post-installed reinforcing bars including test series 15 for effects of fire on bond stress.

7.0 IDENTIFICATION

- 7.1** The ICC-ES mark of conformity, electronic labeling, or the evaluation report number (ICC-ES ESR-3814) along with the name, registered trademark, or registered logo of the report holder must be included in the product label.
- 7.2** In addition, Hilti HIT-RE 500 V3 adhesive is identified by packaging labeled with the manufacturer's name (Hilti Corp.) and address, product name, lot number, expiration date.
- 7.3** Hilti HIS-N and HIS-RN inserts are identified by packaging labeled with the manufacturer's name (Hilti Corp.) and address, anchor name and size, and evaluation report number (ESR-3814). Threaded rods, nuts, washers, bolts, cap screws, and deformed reinforcing bars are standard elements and must conform to applicable national or international specifications.
- 7.4** The report holder's contact information is the following:

HILTI, INC.
7250 DALLAS PARKWAY, SUITE 1000
PLANO, TEXAS 75024
(800) 879-8000
www.hilti.com

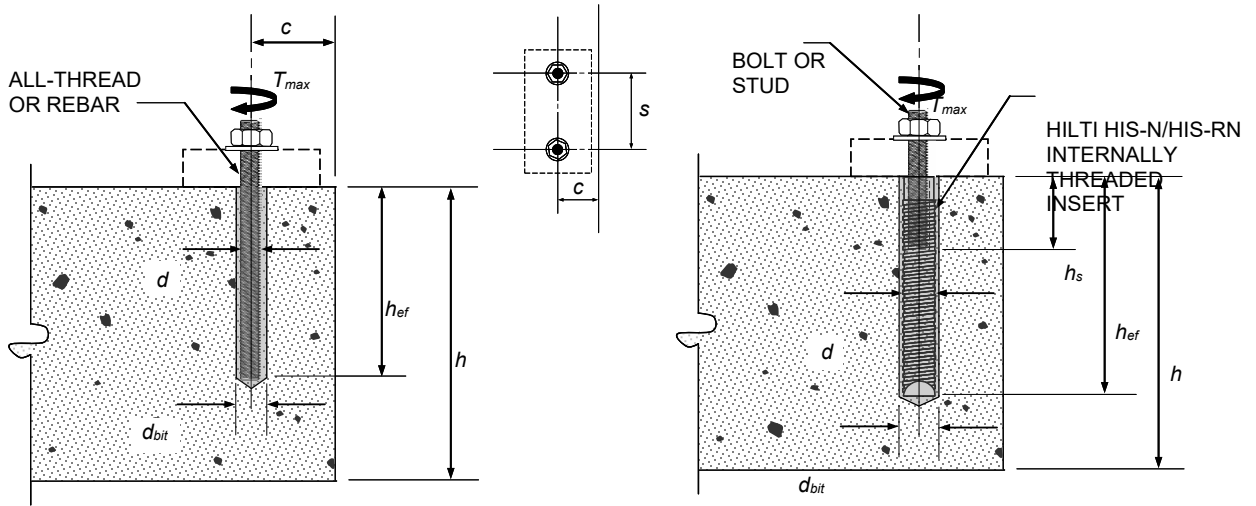

THREADED ROD/REINFORCING BAR

HIS-N AND HIS-RN INSERTS

FIGURE 1—INSTALLATION PARAMETERS FOR POST-INSTALLED ADHESIVE ANCHORS

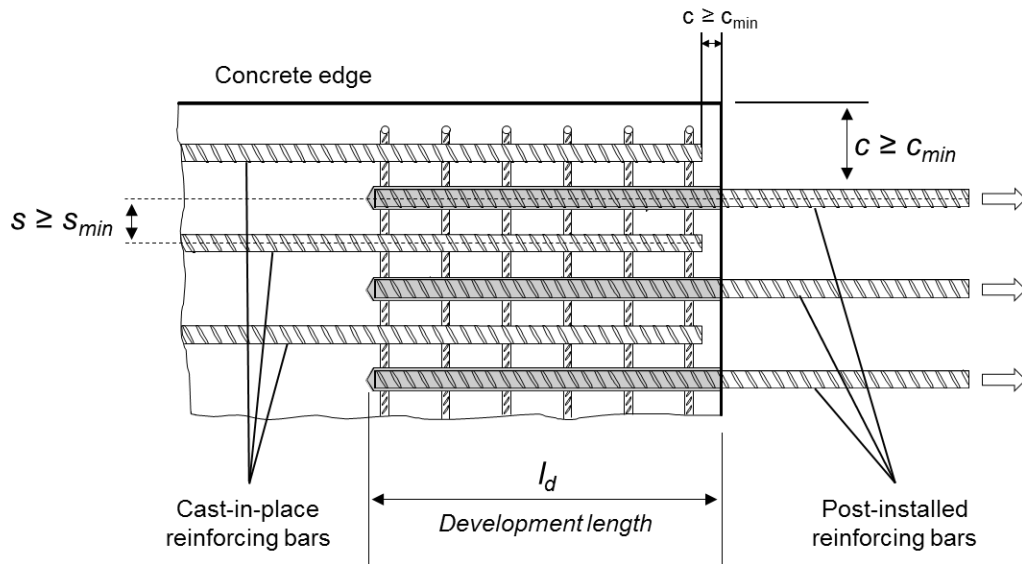

FIGURE 2—INSTALLATION PARAMETERS FOR POST-INSTALLED REINFORCING BARS

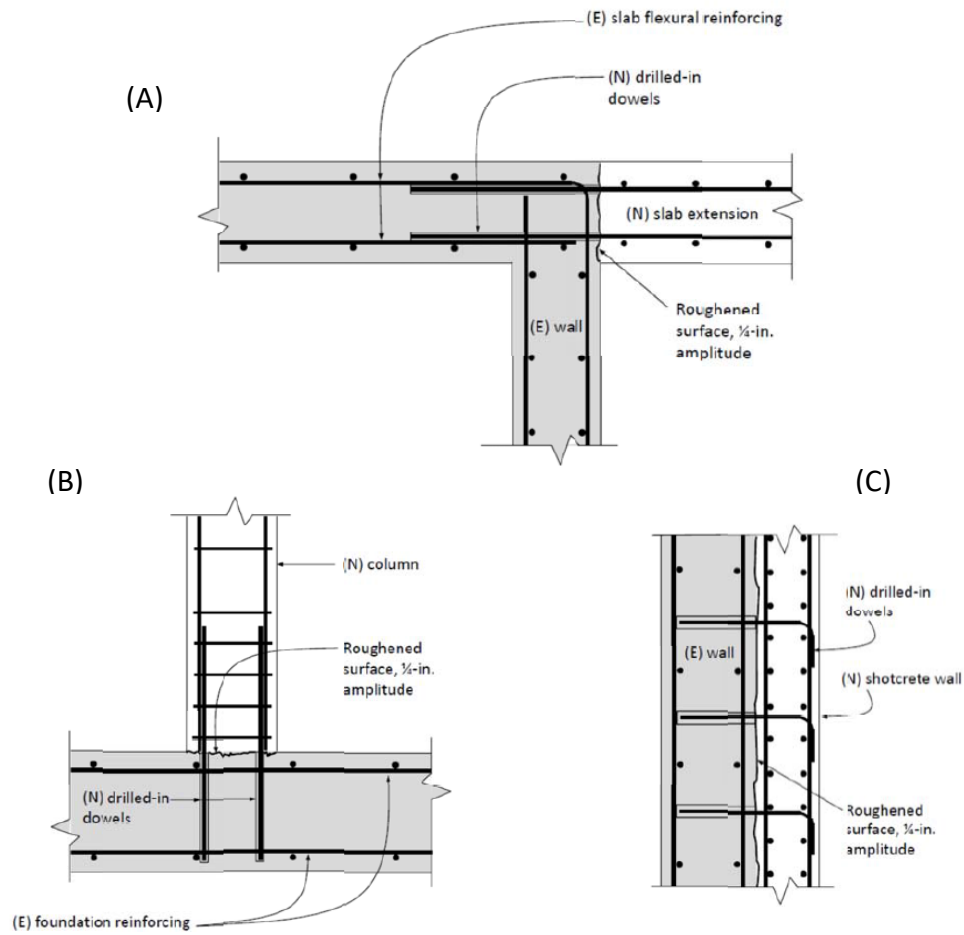
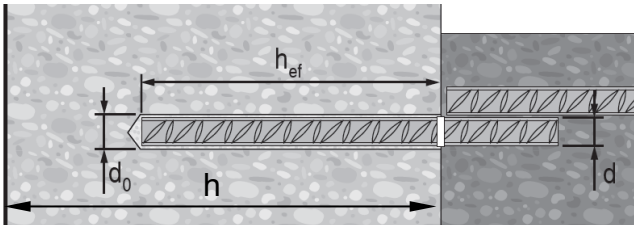

FIGURE 3—(A) TENSION LAP SPLICE WITH EXISTING FLEXURAL REINFORCEMENT; (B) TENSION DEVELOPMENT OF COLUMN DOWELS; (C) DEVELOPMENT OF SHEAR DOWELS FOR NEW ONLAY SHEAR WALL

DEFORMED REINFORCEMENT



EU Rebar

$\varnothing d$ [mm]	$\varnothing d_0$ [mm]	h_{ef} [mm]
8	12	60...480
10	14	60...600
12	16	70...720
14	18	75...840
16	20	80...960
18	22	85...1080
20	25	90...1200
22	28	95...1320
24	32	96...1440
25	32	100...1500
26	35	104...1560
28	35	112...1680
30	37	120...1800
32	40	128...1920

US Rebar

d	$\varnothing d_0$ [inch]	h_{ef} [inch]
# 3	1/2	2 3/8...22 1/2
# 4	5/8	2 3/4...30
# 5	3/4	3 1/8...37 1/2
# 6	7/8	3 1/2...15
	1	15...45
# 7	1	3 1/2...17 1/2
	1 1/8	17 1/2...52 1/2
# 8	1 1/8	4...20
	1 1/4	20...60
# 9	1 3/8	4 1/2...67 1/2
# 10	1 1/2	5...75
# 11	1 3/4	5 1/2...82 1/2

CA Rebar

d	$\varnothing d_0$ [inch]	h_{ef} [mm]
10 M	9/16	70...678
15 M	3/4	80...960
20 M	1	90...1170
25 M	1 1/4 (32 mm)	101...1512
30 M	1 1/2	120...1794

FIGURE 4—INSTALLATION PARAMETERS

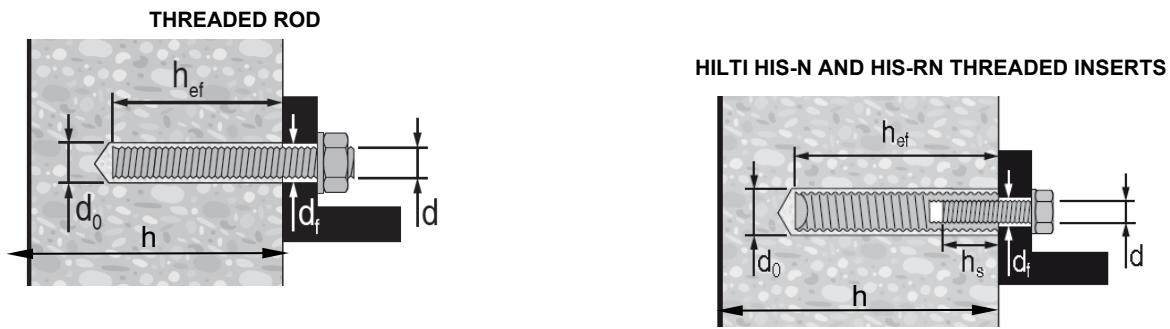

HAS / HIT-V

 Ø d [inch]	Ø d ₀ [inch]	h _{ef} [inch]	Ø d _f [inch]	T _{max} [ft-lb]	T _{max} [Nm]
3/8	7/16	2 3/8... 7 1/2	7/16	15	20
1/2	9/16	2 3/4... 10	9/16	30	41
5/8	3/4	3 1/8... 12 1/2	11/16	60	81
3/4	7/8	3 1/2... 15	13/16	100	136
7/8	1	3 1/2... 17 1/2	15/16	125	169
1	1 1/8	4... 20	1 1/8	150	203
1 1/4	1 3/8	5... 25	1 3/8	200	271

 Ø d [inch]	Ø d ₀ [inch]	h _{ef} [inch]	Ø d _f [inch]	h _s [inch]	T _{max} [ft-lb]	T _{max} [Nm]
3/8	1 1/16	4 3/8	7/16	3/8... 15/16	15	20
1/2	7/8	5	9/16	1/2... 1 3/16	30	41
5/8	1 1/8	6 3/4	1 1/16	5/8... 1 1/2	60	81
3/4	1 1/4	8 1/8	1 3/16	3/4... 1 7/8	100	136

HIT-V

 Ø d [mm]	Ø d ₀ [mm]	h _{ef} [mm]	Ø d _f [mm]	T _{max} [Nm]
M8	10	60...160	9	10
M10	12	60...200	12	20
M12	14	70...240	14	40
M16	18	80...320	18	80
M20	22	90...400	22	150
M24	28	100...480	26	200
M27	30	110...540	30	270
M30	35	120...600	33	300





 Ø d [mm]	Ø d ₀ [mm]	h _{ef} [mm]	Ø d _f [mm]	h _s [mm]	T _{max} [Nm]
M8	14	90	9	8...20	10
M10	18	110	12	10...25	20
M12	22	125	14	12...30	40
M16	28	170	18	16...40	80
M20	32	205	22	20...50	150

FIGURE 4—INSTALLATION PARAMETERS (Continued)

TABLE 1—DESIGN TABLE INDEX

Design Table		Fractional		Metric			
		Table	Page	Table	Page		
	Steel Strength - N_{sa} , V_{sa}	6A	16	14	23		
	Concrete Breakout - N_{cb} , N_{cbg} , V_{cb} , V_{cbg} , V_{cp} , V_{cpq}	7	18	15	24		
	Bond Strength - N_a , N_{ag}	11-13	21-22	19-21	28-29		
	Steel Strength - N_{sa} , V_{sa}	26	33	26	33		
	Concrete Breakout - N_{cb} , N_{cbg} , V_{cb} , V_{cbg} , V_{cp} , V_{cpq}	27	34	27	34		
	Bond Strength - N_a , N_{ag}	28-30	35-37	28-30	35-37		
Design Table		Fractional		EU Metric		Canadian	
		Table	Page	Table	Page	Table	Page
	Steel Strength - N_{sa} , V_{sa}	6B	17	14	23	22	30
	Concrete Breakout - N_{cb} , N_{cbg} , V_{cb} , V_{cbg} , V_{cp} , V_{cpq}	7	18	15	24	23	30
	Bond Strength - N_a , N_{ag}	8-10	19-20	16-18	25-27	24-25B	31-32
	Determination of development length for post-installed reinforcing bar connections	31	37	32	38	33	38

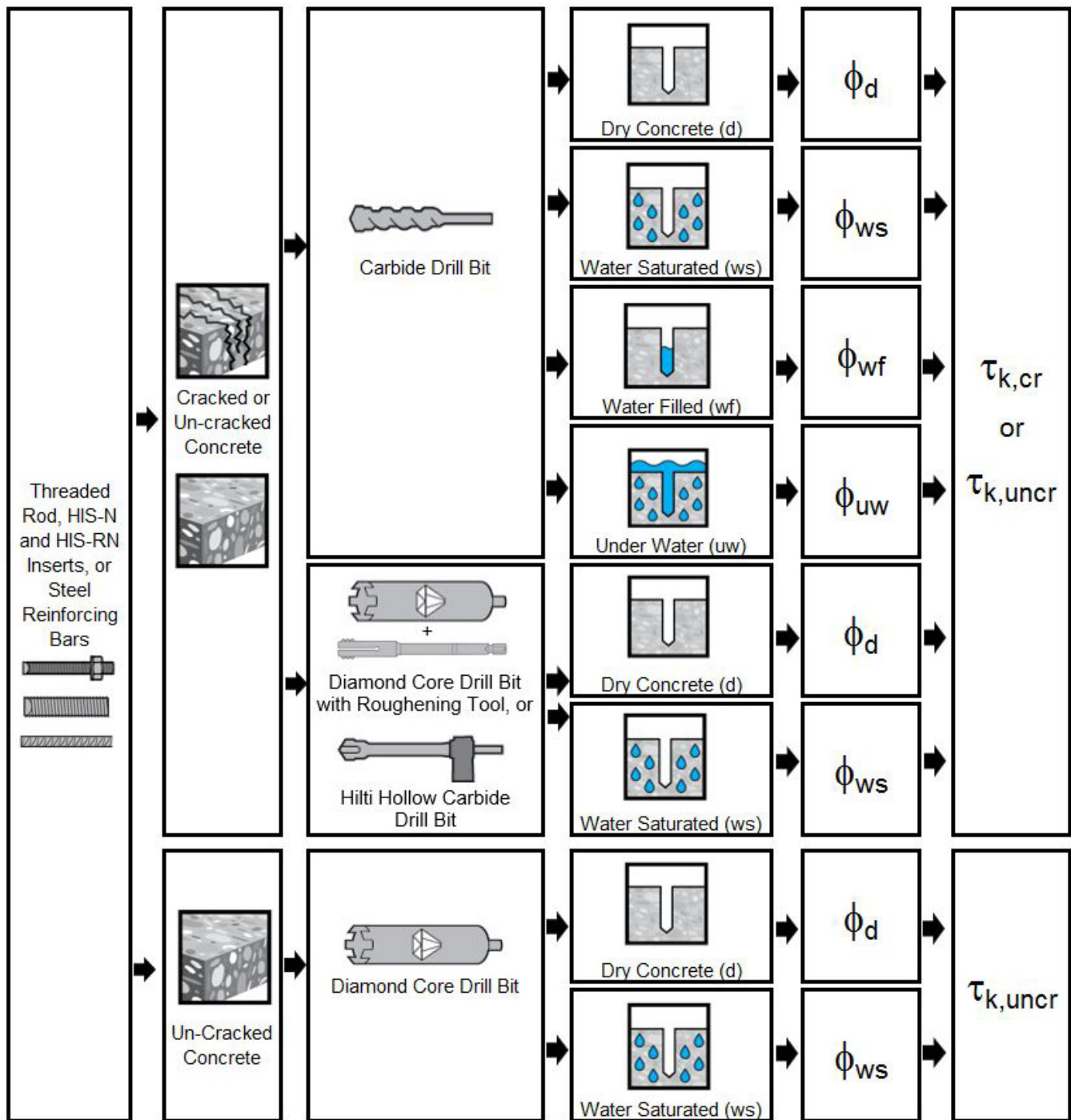

FIGURE 5—FLOWCHART FOR THE ESTABLISHMENT OF DESIGN BOND STRENGTH

TABLE 2—SPECIFICATIONS AND PHYSICAL PROPERTIES OF COMMON CARBON AND STAINLESS STEEL THREADED ROD MATERIALS¹

THREADED ROD SPECIFICATION			Minimum specified ultimate strength, f_{uta}	Minimum specified yield strength 0.2 percent offset, f_{ya}	f_{uta}/f_{ya}	Elongation, min. percent ⁷	Reduction of Area, min. percent	Specification for nuts ⁸
CARBON STEEL	ASTM A193 ² Grade B7 ≤ 2 1/2 in. (≤ 64 mm)	psi (MPa)	125,000 (862)	105,000 (724)	1.19	16	50	ASTM A563 Grade DH
	ASTM F568M ³ Class 5.8 M5 (1/4 in.) to M24 (1 in.) (equivalent to ISO 898-1)	psi (MPa)	72,500 (500)	58,000 (400)	1.25	10	35	ASTM A563 Grade DH ⁹ DIN 934 (8-A2K)
	ASTM F1554, Grade 36 ⁷	psi (MPa)	58,000 (400)	36,000 (248)	1.61	23	40	ASTM A194 or ASTM A563
	ASTM F1554, Grade 55 ⁷	psi (MPa)	75,000 (517)	55,000 (379)	1.36	21	30	ASTM A194 or ASTM A563
	ASTM F1554, Grade 105 ⁷	psi (MPa)	125,000 (862)	105,000 (724)	1.19	15	45	ASTM A194 or ASTM A563
	ISO 898-1 ⁴ Class 5.8	MPa (psi)	500 (72,500)	400 (58,000)	1.25	22	-	DIN 934 Grade 6
	ISO 898-1 ⁴ Class 8.8	MPa (psi)	800 (116,000)	640 (92,800)	1.25	12	52	DIN 934 Grade 8
STAINLESS STEEL	ASTM F593 ⁵ CW1 (316) 1/4-in. to 3/8-in.	psi (MPa)	100,000 (689)	65,000 (448)	1.54	20	-	ASTM F594
	ASTM F593 ⁵ CW2 (316) 3/4-in. to 1 1/2-in.	psi (MPa)	85,000 (586)	45,000 (310)	1.89	25	-	ASTM F594
	ASTM A193 Grade 8(M), Class 1 ² - 1 1/4-in.	psi (MPa)	75,000 (517)	30,000 (207)	2.50	30	50	ASTM F594
	ISO 3506-1 ⁶ A4-70 M8 – M24	MPa (psi)	700 (101,500)	450 (65,250)	1.56	40	-	ISO 4032
	ISO 3506-1 ⁶ A4-50 M27 – M30	MPa (psi)	500 (72,500)	210 (30,450)	2.38	40	-	ISO 4032

¹Hilti HIT-RE 500 V3 adhesive may be used in conjunction with all grades of continuously threaded carbon or stainless steel rod (all-thread) that comply with the code reference standards and that have thread characteristics comparable with ANSI B1.1 UNC Coarse Thread Series or ANSI B1.13M M Profile Metric Thread Series. Values for threaded rod types and associated nuts supplied by Hilti are provided here.

²Standard Specification for Alloy-Steel and Stainless Steel Bolting Materials for High-Temperature Service

³Standard Specification for Carbon and Alloy Steel Externally Threaded Metric Fasteners

⁴Mechanical properties of fasteners made of carbon steel and alloy steel – Part 1: Bolts, screws and studs

⁵Standard Steel Specification for Stainless Steel Bolts, Hex Cap Screws, and Studs

⁶Mechanical properties of corrosion-resistant stainless steel fasteners – Part 1: Bolts, screws and studs

⁷Based on 2-in. (50 mm) gauge length except for A 193, which are based on a gauge length of 4d and ISO 898, which is based on 5d.

⁸Nuts of other grades and styles having specified proof load stresses greater than the specified grade and style are also suitable. Nuts must have specified proof load stresses equal to or greater than the minimum tensile strength of the specified threaded rod.

⁹Nuts for fractional rods.

TABLE 3—SPECIFICATIONS AND PHYSICAL PROPERTIES OF COMMON STEEL REINFORCING BARS

REINFORCING BAR SPECIFICATION		Minimum specified ultimate strength, f_{uta}	Minimum specified yield strength, f_{ya}
			
ASTM A615 ¹ Gr. 60	psi (MPa)	80,000 (550)	60,000 (414)
ASTM A615 ¹ Gr. 40	psi (MPa)	60,000 (414)	40,000 (276)
ASTM A706 ² Gr. 60	psi (MPa)	80,000 (550)	60,000 (414)
DIN 488 ³ BSt 500	MPa (psi)	550 (79,750)	500 (72,500)
CAN/CSA-G30.18 ⁴ Gr. 400	MPa (psi)	540 (78,300)	400 (58,000)

¹Standard Specification for Deformed and Plain Carbon Steel Bars for Concrete Reinforcement
²Standard Specification for Low Alloy Steel Deformed and Plain Bars for Concrete Reinforcement
³Reinforcing steel; reinforcing steel bars; dimensions and masses
⁴Billet-Steel Bars for Concrete Reinforcement

TABLE 4—SPECIFICATIONS AND PHYSICAL PROPERTIES OF FRACTIONAL AND METRIC HIS-N AND HIS-RN INSERTS



HILTI HIS-N AND HIS-RN INSERTS		Minimum specified ultimate strength, f_{uta}	Minimum specified yield strength, f_{ya}
			
Carbon Steel DIN EN 10277-3 11SMnPb30+c or DIN 1561 9SMnPb28K	psi (MPa)	71,050 (490)	56,550 (390)
Stainless Steel EN 10088-3 X5CrNiMo 17-12-2	psi (MPa)	101,500 (700)	50,750 (350)

TABLE 5—SPECIFICATIONS AND PHYSICAL PROPERTIES OF COMMON BOLTS, CAP SCREWS AND STUDS FOR USE WITH HIS-N AND HIS-RN INSERTS^{1,2}

BOLT, CAP SCREW OR STUD SPECIFICATION		Minimum specified ultimate strength f_{uta}	Minimum specified yield strength 0.2 percent offset f_{ya}	f_{uta}/f_{ya}	Elongation, min.	Reduction of Area, min.	Specification for nuts ⁶
							
ASTM A193 Grade B7	psi (MPa)	125,000 (862)	105,000 (724)	1.119	16	50	ASTM A563 Grade DH
SAE J429 ³ Grade 5	psi (MPa)	120,000 (828)	92,000 (634)	1.30	14	35	SAE J995
ASTM A325 ⁴ 1/2 to 1-in.	psi (MPa)	120,000 (828)	92,000 (634)	1.30	14	35	A563 C, C3, D, DH, DH3 Heavy Hex
ASTM A193 ⁵ Grade B8M (AISI 316) for use with HIS-RN	psi (MPa)	110,000 (759)	95,000 (655)	1.16	15	45	ASTM F594 ⁷ Alloy Group 1, 2 or 3
ASTM A193 ⁵ Grade B8T (AISI 321) for use with HIS-RN	psi (MPa)	125,000 (862)	100,000 (690)	1.25	12	35	ASTM F594 ⁷ Alloy Group 1, 2 or 3

¹Minimum Grade 5 bolts, cap screws or studs must be used with carbon steel HIS inserts.
²Only stainless steel bolts, cap screws or studs must be used with HIS-RN inserts.
³Mechanical and Material Requirements for Externally Threaded Fasteners
⁴Standard Specification for Structural Bolts, Steel, Heat Treated, 120/105 ksi Minimum Tensile Strength
⁵Standard Specification for Alloy-Steel and Stainless Steel Bolting Materials for High-Temperature Service
⁶Nuts must have specified minimum proof load stress equal to or greater than the specified minimum full-size tensile strength of the specified stud.
⁷Nuts for stainless steel studs must be of the same alloy group as the specified bolt, cap screw, or stud.

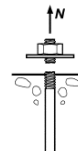

Fractional Threaded Rod

Steel Strength

TABLE 6A—STEEL DESIGN INFORMATION FOR FRACTIONAL THREADED ROD

DESIGN INFORMATION		Symbol	Units	Nominal rod diameter (in.) ¹						
				3/8	1/2	5/8	3/4	7/8	1	1 1/4
Rod O.D.		<i>d</i>	in. (mm)	0.375 (9.5)	0.5 (12.7)	0.625 (15.9)	0.75 (19.1)	0.875 (22.2)	1 (25.4)	1.25 (31.8)
Rod effective cross-sectional area		<i>A_{se}</i>	in. ² (mm ²)	0.0775 (50)	0.1419 (92)	0.2260 (146)	0.3345 (216)	0.4617 (298)	0.6057 (391)	0.9691 (625)
ISO 898-1 Class 5.8	Nominal strength as governed by steel strength	<i>N_{sa}</i>	lb (kN)	5,620 (25.0)	10,290 (45.8)	16,385 (72.9)	24,250 (107.9)	33,470 (148.9)	43,910 (195.3)	70,260 (312.5)
		<i>V_{sa}</i>	lb (kN)	3,370 (15.0)	6,175 (27.5)	9,830 (43.7)	14,550 (64.7)	20,085 (89.3)	26,345 (117.2)	42,155 (187.5)
	Reduction for seismic shear	<i>α_{v,seis}</i>	-	1.0						
	Strength reduction factor <i>φ</i> for tension ²	<i>φ</i>	-	0.65						
		Strength reduction factor <i>φ</i> for shear ²	<i>φ</i>	0.60						
ASTM A193 B7	Nominal strength as governed by steel strength	<i>N_{sa}</i>	lb (kN)	9,685 (43.1)	17,735 (78.9)	28,250 (125.7)	41,810 (186.0)	57,710 (256.7)	75,710 (336.8)	121,135 (538.8)
		<i>V_{sa}</i>	lb (kN)	5,810 (25.9)	10,640 (47.3)	16,950 (75.4)	25,085 (111.6)	34,625 (154.0)	45,425 (202.1)	72,680 (323.3)
	Reduction for seismic shear	<i>α_{v,seis}</i>	-	1.0						
	Strength reduction factor <i>φ</i> for tension ³	<i>φ</i>	-	0.75						
		Strength reduction factor <i>φ</i> for shear ³	<i>φ</i>	0.65						
ASTM F1554 Gr. 36	Nominal strength as governed by steel strength	<i>N_{sa}</i>	lb (kN)	- (-)	8,230 (36.6)	13,110 (58.3)	19,400 (86.3)	26,780 (119.1)	35,130 (156.3)	56,210 (250.0)
		<i>V_{sa}</i>	lb (kN)	- (-)	4,940 (22.0)	7,865 (35.0)	11,640 (51.8)	16,070 (71.5)	21,080 (93.8)	33,725 (150.0)
	Reduction factor, seismic shear	<i>α_{v,seis}</i>	-	0.6						
	Strength reduction factor <i>φ</i> for tension ³	<i>φ</i>	-	0.75						
		Strength reduction factor <i>φ</i> for shear ³	<i>φ</i>	0.65						
ASTM F1554 Gr. 55	Nominal strength as governed by steel strength	<i>N_{sa}</i>	lb (kN)	- (-)	10,645 (47.4)	16,950 (75.4)	25,090 (111.6)	34,630 (154.0)	45,430 (202.1)	72,685 (323.3)
		<i>V_{sa}</i>	lb (kN)	- (-)	6,385 (28.4)	10,170 (45.2)	15,055 (67.0)	20,780 (92.4)	27,260 (121.3)	43,610 (194.0)
	Reduction factor, seismic shear	<i>α_{v,seis}</i>	-	1.0						
	Strength reduction factor <i>φ</i> for tension ³	<i>φ</i>	-	0.75						
		Strength reduction factor <i>φ</i> for shear ³	<i>φ</i>	0.65						
ASTM F1554 Gr. 105	Nominal strength as governed by steel strength	<i>N_{sa}</i>	lb (kN)	- (-)	17,740 (78.9)	28,250 (125.7)	41,815 (186.0)	57,715 (256.7)	75,715 (336.8)	121,135 (538.8)
		<i>V_{sa}</i>	lb (kN)	- (-)	10,645 (47.4)	16,950 (75.4)	25,090 (111.6)	34,630 (154.0)	45,430 (202.1)	72,680 (323.3)
	Reduction factor, seismic shear	<i>α_{v,seis}</i>	-	1.0						
	Strength reduction factor <i>φ</i> for tension ³	<i>φ</i>	-	0.75						
		Strength reduction factor <i>φ</i> for shear ³	<i>φ</i>	0.65						
ASTM F593, CW Stainless	Nominal strength as governed by steel strength	<i>N_{sa}</i>	lb (kN)	7,750 (34.5)	14,190 (63.1)	22,600 (100.5)	28,435 (126.5)	39,245 (174.6)	51,485 (229.0)	- (-)
		<i>V_{sa}</i>	lb (kN)	4,650 (20.7)	8,515 (37.9)	13,560 (60.3)	17,060 (75.9)	23,545 (104.7)	30,890 (137.4)	- (-)
	Reduction factor, seismic shear	<i>α_{v,seis}</i>	-	0.80						
	Strength reduction factor <i>φ</i> for tension ²	<i>φ</i>	-	0.65						
		Strength reduction factor <i>φ</i> for shear ²	<i>φ</i>	0.60						
ASTM A193, Gr. 8(N), Class 1 Stainless	Nominal strength as governed by steel strength	<i>N_{sa}</i>	lb (kN)	-						55,240 (245.7)
		<i>V_{sa}</i>	lb (kN)	-						33,145 (147.4)
	Reduction factor, seismic shear	<i>α_{v,seis}</i>	-	-						0.8
	Strength reduction factor <i>φ</i> for tension ²	<i>φ</i>	-	-						0.75
	Strength reduction factor <i>φ</i> for shear ²	<i>φ</i>	-	-						0.65

For **SI**: 1 inch = 25.4 mm, 1 lbf = 4.448 N. For **pound-inch** units: 1 mm = 0.03937 inches, 1 N = 0.2248 lbf

¹Values provided for common rod material types are based on specified strengths and calculated in accordance with ACI 318-19 Eq. (17.6.1.2) and Eq. (17.7.1.2b), ACI 318-14 Eq. (17.4.1.2) and Eq (17.5.1.2b) or ACI 318-11 Eq. (D-2) and Eq. (D-29), as applicable. Nuts and washers must be appropriate for the rod.

²For use with the load combinations of Section 1605.1 of the 2021 IBC or Section 1605.2 of the 2018, 2015, and 2012 IBC, ACI 318 (-19 and -14) 5.3 or ACI 318-11 9.2, as applicable, as set forth in ACI 318-19 17.5.3 or ACI 318-14 17.3.3 or ACI 318-11 D.4.3, as applicable. If the load combinations of ACI 318-11 Appendix C are used, the appropriate value of *φ* must be determined in accordance with ACI 318-11 D.4.4. Values correspond to a brittle steel element.

³For use with the load combinations of Section 1605.1 of the 2021 IBC or Section 1605.2 of the 2018, 2015, and 2012 IBC, ACI 318 (-19 and -14) 5.3 or ACI 318-11 9.2, as applicable, as set forth in ACI 318-19 17.5.3 or ACI 318-14 17.3.3 or ACI 318-11 D.4.3, as applicable. If the load combinations of ACI 318-11 Appendix C are used, the appropriate value of *φ* must be determined in accordance with ACI 318-11 D.4.4. Values correspond to a ductile steel element.

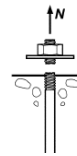

Fractional Reinforcing Bars

Steel Strength

TABLE 6B—STEEL DESIGN INFORMATION FOR FRACTIONAL REINFORCING BARS

DESIGN INFORMATION		Symbol	Units	Nominal Reinforcing bar size (Rebar) ¹							
				#3	#4	#5	#6	#7	#8	#9	#10
Nominal bar diameter		d	in. (mm)	³ / ₈ (9.5)	¹ / ₂ (12.7)	⁵ / ₈ (15.9)	³ / ₄ (19.1)	⁷ / ₈ (22.2)	1 (25.4)	1.128 (28.7)	1.270 (32.3)
Bar effective cross-sectional area		A_{se}	in. ² (mm ²)	0.11 (71)	0.2 (129)	0.31 (199)	0.44 (284)	0.60 (387)	0.79 (510)	1.00 (645)	1.27 (819)
ASTM A615 Grade 40	Nominal strength as governed by steel strength	N_{sa}	lb (kN)	6,600 (29.4)	12,000 (53.4)	18,600 (82.7)	26,400 (117.4)	36,000 (160.1)	47,400 (210.9)	60,000 (266.9)	76,200 (339.0)
		V_{sa}	lb (kN)	3,960 (17.6)	7,200 (32.0)	11,160 (49.6)	15,840 (70.5)	21,600 (96.1)	28,440 (126.5)	36,000 (160.1)	45,720 (203.4)
	Reduction for seismic shear	$\alpha_{V,seis}$	-	0.70							
	Strength reduction factor ϕ for tension ²	ϕ	-	0.65							
	Strength reduction factor ϕ for shear ²	ϕ	-	0.60							
ASTM A615 Grade 60	Nominal strength as governed by steel strength	N_{sa}	lb (kN)	8,800 (39.1)	16,000 (71.2)	24,800 (110.3)	35,200 (156.6)	48,000 (213.5)	63,200 (281.1)	80,000 (355.9)	101,600 (451.9)
		V_{sa}	lb (kN)	5,280 (23.5)	9,600 (42.7)	14,880 (66.2)	21,120 (93.9)	28,800 (128.1)	37,920 (168.7)	48,000 (213.5)	60,960 (271.2)
	Reduction for seismic shear	$\alpha_{V,seis}$	-	0.70							
	Strength reduction factor ϕ for tension ²	ϕ	-	0.65							
	Strength reduction factor ϕ for shear ²	ϕ	-	0.60							
ASTM A706 Grade 60	Nominal strength as governed by steel strength	N_{sa}	lb (kN)	8,800 (39.1)	16,000 (71.2)	24,800 (110.3)	35,200 (156.6)	48,000 (213.5)	63,200 (281.1)	80,000 (355.9)	101,600 (452.0)
		V_{sa}	lb (kN)	5,280 (23.5)	9,600 (42.7)	14,880 (66.2)	21,120 (94.0)	28,800 (128.1)	37,920 (168.7)	48,000 (213.5)	60,960 (271.2)
	Reduction for seismic shear	$\alpha_{V,seis}$	-	0.70							
	Strength reduction factor ϕ for tension ³	ϕ	-	0.75							
	Strength reduction factor ϕ for shear ³	ϕ	-	0.65							

For SI: 1 inch = 25.4 mm, 1 lbf = 4.448 N. For pound-inch units: 1 mm = 0.03937 inches, 1 N = 0.2248 lbf

¹ Values provided for common rebar types are based on specified strengths and calculated in accordance with ACI 318-19 Eq. (17.6.1.2) and Eq. (17.7.1.2b), ACI 318-14 Eq. (17.4.1.2) and Eq. (17.5.1.2b) or ACI 318-11 Eq. (D-2) and Eq. (D-29). Nuts and washers must be appropriate for the rod.

² For use with the load combinations of Section 1605.1 of the 2021 IBC or Section 1605.2 of the 2018, 2015, and 2012 IBC, ACI 318 (-19 and -14) 5.3 or ACI 318-11 9.2, as set forth in ACI 318-19 17.5.3 or ACI 318-14 17.3.3 or ACI 318-11 D.4.3. If the load combinations of ACI 318-11 Appendix C are used, the appropriate value of ϕ must be determined in accordance with ACI 318-11 D.4.4. Values correspond to a brittle steel element.

³ For use with the load combinations of Section 1605.1 of the 2021 IBC or Section 1605.2 of the 2018, 2015, and 2012 IBC, ACI 318 (-19 and -14) 5.3 or ACI 318-11 9.2, as set forth in ACI 318-19 17.5.3 or ACI 318-14 17.3.3 or ACI 318-11 D.4.3. If the load combinations of ACI 318-11 Appendix C are used, the appropriate value of ϕ must be determined in accordance with ACI 318-11 D.4.4. Values correspond to a ductile steel element.



Fractional Threaded Rod and Reinforcing Bars

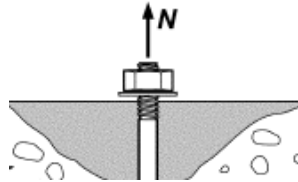

Concrete Breakout Strength

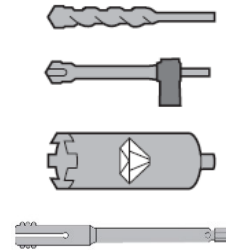

Carbide Bit or Hilti Hollow Carbide Bit
Diamond Core Bit + Roughening Tool, or Diamond Core Bit

TABLE 7—CONCRETE BREAKOUT DESIGN INFORMATION FOR FRACTIONAL THREADED ROD AND REINFORCING BARS ALL DRILLING METHODS¹

DESIGN INFORMATION	Symbol	Units	Nominal rod diameter (in.) / Reinforcing bar size											
			3/8 or #3	1/2	#4	5/8	#5	3/4	#6	7/8	#7	1 or #8	#9	1 1/4 or #10
Effectiveness factor for cracked concrete	$k_{c,cr}$	in-lb (SI)	17 (7.1)											
Effectiveness factor for uncracked concrete	$k_{c,uncr}$	in-lb (SI)	24 (10)											
Minimum Embedment	$h_{ef,min}$	in. (mm)	2 3/8 (60)	2 3/4 (70)	2 3/8 (60)	3 1/8 (79)	3 (76)	3 1/2 (89)	3 (76)	3 1/2 (89)	3 3/8 (85)	4 (102)	4 1/2 (114)	5 (127)
Maximum Embedment	$h_{ef,max}$	in. (mm)	7 1/2 (191)	10 (254)	10 (254)	12 1/2 (318)	12 1/2 (318)	15 (381)	15 (381)	17 1/2 (445)	17 1/2 (445)	20 (508)	22 1/2 (572)	25 (635)
Min. anchor spacing ³	s_{min}	in. (mm)	1 7/8 (48)	2 1/2 (64)	2 1/2 (64)	3 1/8 (79)	3 1/8 (79)	3 3/4 (95)	3 3/4 (95)	4 3/8 (111)	4 3/8 (111)	5 (127)	5 5/8 (143)	6 1/4 (159)
Min. edge distance ³	c_{min}	-	5d; or see Section 4.1.9 of this report for design with reduced minimum edge distances											
Minimum concrete thickness	h_{min}	in. (mm)	$h_{ef} + 1 1/4$ ($h_{ef} + 30$)				$h_{ef} + 2d_o^{(4)}$							
Critical edge distance – splitting (for uncracked concrete)	c_{ac}	-	See Section 4.1.10 of this report.											
Strength reduction factor for tension, concrete failure modes ²	ϕ	-	0.65											
Strength reduction factor for shear, concrete failure modes ²	ϕ	-	0.70											

For SI: 1 inch ≅ 25.4 mm, 1 lbf = 4.448 N, 1 psi = 0.006897 MPa.

For pound-inch units: 1 mm = 0.03937 inches, 1 N = 0.2248 lbf, 1 MPa = 145.0 psi

¹Additional setting information is described in Figure 8A and 8B, Manufacturers Printed Installation Instructions (MPII).

²The strength reduction factor applies when the load combinations from the IBC or ACI 318 are used and the requirements of ACI 318-19 17.5.3, ACI 318-14 17.3.3 or ACI 318-11 D.4.3, as applicable, are met. If the load combinations of ACI 318-11 Appendix C are used, the appropriate strength reduction factor must be determined in accordance with ACI 318-11 D.4.4.

³For installations with 1 3/4-inch edge distance, refer to Section 4.1.9 for spacing and maximum torque requirements.

⁴ d_o = hole diameter.

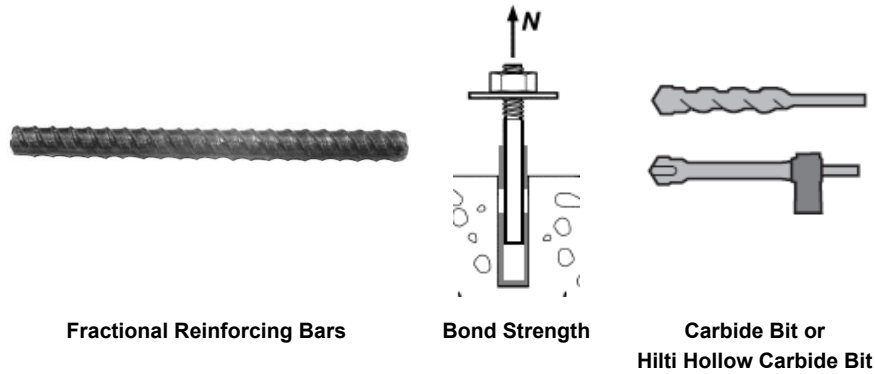

TABLE 8—BOND STRENGTH DESIGN INFORMATION FOR FRACTIONAL REINFORCING BARS IN HOLES DRILLED WITH A HAMMER DRILL AND CARBIDE BIT (OR HILTI HOLLOW CARBIDE DRILL BIT)¹

DESIGN INFORMATION			Symbol	Units	Nominal reinforcing bar size								
					#3	#4	#5	#6	#7	#8	#9	#10	
Minimum Embedment			$h_{ef,min}$	in. (mm)	2 ³ / ₈ (60)	2 ³ / ₈ (60)	3 (76)	3 (76)	3 ³ / ₈ (85)	4 (102)	4 ¹ / ₂ (114)	5 (127)	
Maximum Embedment			$h_{ef,max}$	in. (mm)	7 ¹ / ₂ (191)	10 (254)	12 ¹ / ₂ (318)	15 (381)	17 ¹ / ₂ (445)	20 (508)	22 ¹ / ₂ (572)	25 (635)	
Dry concrete and Water Saturated Concrete	Temperature range A ²	Characteristic bond strength in cracked concrete	$\tau_{k,cr}$	psi (MPa)	1,350 (9.3)	1,360 (9.4)	1,390 (9.6)	1,410 (9.7)	1,410 (9.7)	1,420 (9.8)	1,390 (9.6)	1,340 (9.3)	
		Characteristic bond strength in uncracked concrete	$\tau_{k,uncr}$	psi (MPa)	1,770 (12.2)	1,740 (12.0)	1,720 (11.9)	1,690 (11.7)	1,670 (11.5)	1,640 (11.3)	1,620 (11.2)	1,590 (11.0)	
	Temperature range B ²	Characteristic bond strength in cracked concrete	$\tau_{k,cr}$	psi (MPa)	930 (6.4)	940 (6.5)	960 (6.6)	970 (6.7)	980 (6.7)	980 (6.8)	960 (6.6)	930 (6.4)	
		Characteristic bond strength in uncracked concrete	$\tau_{k,uncr}$	psi (MPa)	1,220 (8.4)	1,200 (8.3)	1,190 (8.2)	1,170 (8.1)	1,150 (7.9)	1,130 (7.8)	1,120 (7.7)	1,100 (7.6)	
	Anchor Category		-	-	-	1	1	1	1	1	1	1	1
	Strength Reduction factor		ϕ_{cd}, ϕ_{ws}	-	-	0.65	0.65	0.65	0.65	0.65	0.65	0.65	0.65
Water-filled hole	Temperature range A ²	Characteristic bond strength in cracked concrete	$\tau_{k,cr}$	psi (MPa)	1,000 (6.9)	1,010 (6.9)	1,040 (7.2)	1,060 (7.3)	1,070 (7.4)	1,090 (7.5)	1,070 (7.4)	1,050 (7.2)	
		Characteristic bond strength in uncracked concrete	$\tau_{k,uncr}$	psi (MPa)	1,300 (9.0)	1,290 (8.9)	1,290 (8.9)	1,280 (8.8)	1,270 (8.7)	1,260 (8.7)	1,240 (8.6)	1,240 (8.6)	
	Temperature range B ²	Characteristic bond strength in cracked concrete	$\tau_{k,cr}$	psi (MPa)	690 (4.7)	700 (4.8)	720 (5.0)	730 (5.0)	740 (5.1)	750 (5.2)	740 (5.1)	720 (5.0)	
		Characteristic bond strength in uncracked concrete	$\tau_{k,uncr}$	psi (MPa)	900 (6.2)	890 (6.1)	890 (6.1)	880 (6.1)	870 (6.0)	870 (6.0)	860 (5.9)	860 (5.9)	
	Anchor Category		-	-	-	3	3	3	3	3	3	3	3
	Strength Reduction factor		ϕ_{wf}	-	-	0.45	0.45	0.45	0.45	0.45	0.45	0.45	0.45
Submerged concrete	Temperature range A ²	Characteristic bond strength in cracked concrete	$\tau_{k,cr}$	psi (MPa)	860 (5.9)	890 (6.1)	920 (6.3)	940 (6.5)	960 (6.6)	990 (6.9)	970 (6.7)	980 (6.8)	
		Characteristic bond strength in uncracked concrete	$\tau_{k,uncr}$	psi (MPa)	1,140 (7.9)	1,130 (7.8)	1,140 (7.9)	1,140 (7.9)	1,140 (7.9)	1,150 (7.9)	1,130 (7.8)	1,150 (8.0)	
	Temperature range B ²	Characteristic bond strength in cracked concrete	$\tau_{k,cr}$	psi (MPa)	590 (4.1)	610 (4.2)	630 (4.4)	650 (4.5)	660 (4.6)	690 (4.7)	670 (4.6)	680 (4.7)	
		Characteristic bond strength in uncracked concrete	$\tau_{k,uncr}$	psi (MPa)	790 (5.4)	780 (5.4)	790 (5.4)	790 (5.4)	790 (5.4)	790 (5.5)	790 (5.4)	800 (5.5)	
	Anchor Category		-	-	-	3	3	3	3	3	3	3	3
	Strength Reduction factor		ϕ_{uw}	-	-	0.45	0.45	0.45	0.45	0.45	0.45	0.45	0.45
Reduction for seismic tension			$\alpha_{N,seis}$	-	-	0.9	0.9	0.9	0.9	0.9	0.9	0.9	

For SI: 1 inch = 25.4 mm, 1 lbf = 4.448 N, 1 psi = 0.006897 MPa.

For pound-inch units: 1 mm = 0.03937 inches, 1 N = 0.2248 lbf, 1 MPa = 145.0 psi

¹Bond strength values correspond to concrete compressive strength $f'_c = 2,500$ psi (17.2 MPa). For concrete compressive strength, f'_c , between 2,500 psi (17.2 MPa) and 8,000 psi (55.2 MPa), the tabulated characteristic bond strength may be increased by a factor of $(f'_c / 2,500)^{0.25}$ for uncracked concrete [For SI: $(f'_c / 17.2)^{0.25}$] and $(f'_c / 2,500)^{0.15}$ for cracked concrete [For SI: $(f'_c / 17.2)^{0.15}$]. See Section 4.1.4 of this report for bond strength determination.

²Temperature range A: Maximum short term temperature = 130°F (55°C), Maximum long term temperature = 110°F (43°C).

Temperature range B: Maximum short term temperature = 176°F (80°C), Maximum long term temperature = 110°F (43°C).

Short term elevated concrete temperatures are those that occur over brief intervals, e.g., as a result of diurnal cycling. Long term concrete temperatures are roughly constant over significant periods of time.

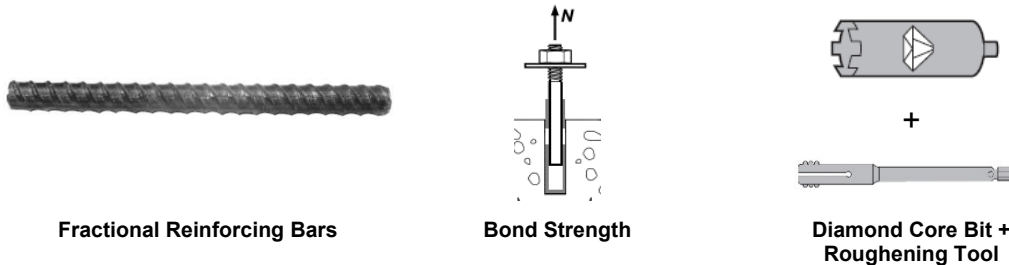

TABLE 9—BOND STRENGTH DESIGN INFORMATION FOR FRACTIONAL REINFORCING BARS IN HOLES CORE DRILLED WITH A DIAMOND CORE BIT AND ROUGHENED WITH A HILTI ROUGHENING TOOL¹

DESIGN INFORMATION			Symbol	Units	Nominal reinforcing bar size					
					#5	#6	#7	#8	#9	
Minimum Embedment			$h_{ef,min}$	in. (mm)	3 (76)	3 (76)	3 ³ / ₈ (85)	4 (102)	4 ¹ / ₂ (115)	
Maximum Embedment			$h_{ef,max}$	in. (mm)	12 ¹ / ₂ (318)	11 ¹ / ₄ (286)	17 ¹ / ₂ (445)	20 (508)	22 ¹ / ₂ (573)	
Dry and water saturated concrete	Temperature range A ²	Characteristic bond strength in cracked concrete	$\tau_{k,cr}$	psi (MPa)	970 (6.7)	990 (6.8)	990 (6.8)	995 (6.9)	970 (6.7)	
		Characteristic bond strength in uncracked concrete	$\tau_{k,uncr}$	psi (MPa)	1,720 (11.9)	1,690 (11.7)	1,670 (11.5)	1,640 (11.3)	1,620 (11.2)	
	Temperature range B ²	Characteristic bond strength in cracked concrete	$\tau_{k,cr}$	psi (MPa)	670 (4.6)	680 (4.7)	680 (4.7)	690 (4.8)	670 (4.6)	
		Characteristic bond strength in uncracked concrete	$\tau_{k,uncr}$	psi (MPa)	1,190 (8.2)	1,170 (8.1)	1,150 (7.9)	1,130 (7.8)	1,120 (7.7)	
	Anchor Category			-	-	1	1	1	1	1
	Strength Reduction factor			ϕ_d, ϕ_{ws}	-	0.65	0.65	0.65	0.65	0.65
	Reduction for seismic tension			$\alpha_{N,seis}$	-	0.9	0.9	0.9	0.9	0.9

For SI: 1 inch \equiv 25.4 mm, 1 lbf = 4.448 N, 1 psi = 0.006897 MPa.

For pound-inch units: 1 mm = 0.03937 inches, 1 N = 0.2248 lbf, 1 MPa = 145.0 psi

¹Bond strength values correspond to concrete compressive strength in the range 2,500 psi \leq $f'_c \leq$ 8,000 psi.

²Temperature range A: Maximum short term temperature = 130°F (55°C), Maximum long term temperature = 110°F (43°C).

Temperature range B: Maximum short term temperature = 176°F (80°C), Maximum long term temperature = 110°F (43°C).

Short term elevated concrete temperatures are those that occur over brief intervals, e.g., as a result of diurnal cycling. Long term concrete temperatures are roughly constant over significant periods of time.

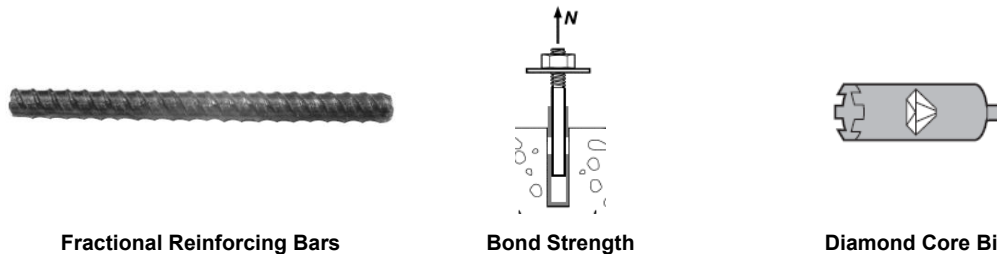

TABLE 10—BOND STRENGTH DESIGN INFORMATION FOR FRACTIONAL REINFORCING BARS IN HOLES CORE DRILLED WITH A DIAMOND CORE BIT¹

DESIGN INFORMATION			Symbol	Units	Nominal reinforcing bar size							
					#3	#4	#5	#6	#7	#8	#9	#10
Minimum Embedment			$h_{ef,min}$	in. (mm)	2 ³ / ₈ (60)	2 ³ / ₈ (60)	3 (76)	3 (76)	3 ³ / ₈ (85)	4 (102)	4 ¹ / ₂ (114)	5 (127)
Maximum Embedment			$h_{ef,max}$	in. (mm)	7 ¹ / ₂ (191)	10 (254)	12 ¹ / ₂ (318)	15 (381)	17 ¹ / ₂ (445)	20 (508)	22 ¹ / ₂ (572)	25 (635)
Dry and water saturated concrete	Temperature range A ²	Characteristic bond strength in uncracked concrete	$\tau_{k,uncr}$	psi (MPa)	1,150 (8.0)	1,150 (8.0)	1,150 (8.0)	1,150 (8.0)	1,150 (8.0)	1,150 (8.0)	1,150 (8.0)	1,150 (8.0)
	Temperature range B ²	Characteristic bond strength in uncracked concrete	$\tau_{k,uncr}$	psi (MPa)	800 (5.5)	800 (5.5)	800 (5.5)	800 (5.5)	800 (5.5)	800 (5.5)	800 (5.5)	800 (5.5)
	Anchor Category			-	-	2	2	3	3	3	3	3
	Strength Reduction factor			ϕ_d, ϕ_{ws}	-	0.55	0.55	0.45	0.45	0.45	0.45	0.45

For SI: 1 inch \equiv 25.4 mm, 1 lbf = 4.448 N, 1 psi = 0.006897 MPa.

For pound-inch units: 1 mm = 0.03937 inches, 1 N = 0.2248 lbf, 1 MPa = 145.0 psi

¹Bond strength values correspond to concrete compressive strength $f'_c = 2,500$ psi (17.2 MPa). For concrete compressive strength, f'_c , between 2,500 psi (17.2 MPa) and 8,000 psi (55.2 MPa), the tabulated characteristic bond strength may be increased by a factor of $(f'_c / 2,500)^{0.25}$ for uncracked concrete. [For SI: $(f'_c / 17.2)^{0.25}$]. See Section 4.1.4 of this report for bond strength determination.

²Temperature range A: Maximum short term temperature = 130°F (55°C), Maximum long term temperature = 110°F (43°C).

Temperature range B: Maximum short term temperature = 176°F (80°C), Maximum long term temperature = 110°F (43°C).

Short term elevated concrete temperatures are those that occur over brief intervals, e.g., as a result of diurnal cycling. Long term concrete temperatures are roughly constant over significant periods of time.

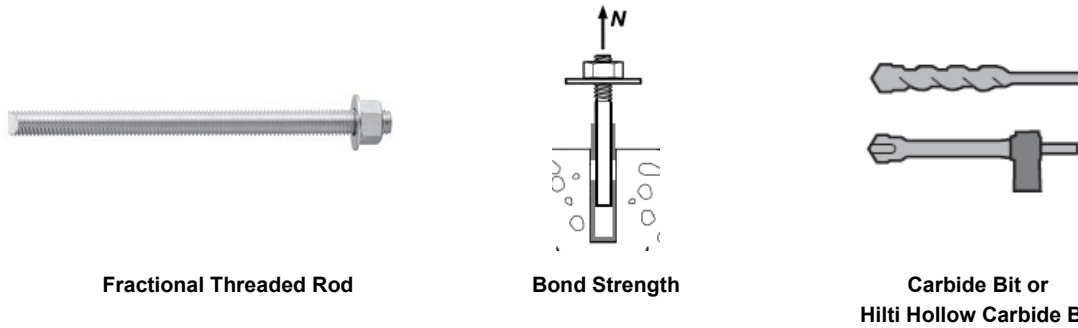

TABLE 11—BOND STRENGTH DESIGN INFORMATION FOR FRACTIONAL THREADED ROD IN HOLES DRILLED WITH A HAMMER DRILL AND CARBIDE BIT (OR HILTI HOLLOW CARBIDE DRILL BIT)¹

DESIGN INFORMATION			Symbol	Units	Nominal rod diameter (in.)							
					3/8	1/2	5/8	3/4	7/8	1	1 1/4	
Minimum Embedment			$h_{ef,min}$	in. (mm)	2 3/8 (60)	2 3/4 (70)	3 1/8 (79)	3 1/2 (89)	3 1/2 (89)	4 (102)	5 (127)	
Maximum Embedment			$h_{ef,max}$	in. (mm)	7 1/2 (191)	10 (254)	12 1/2 (318)	15 (381)	17 1/2 (445)	20 (508)	25 (635)	
Dry concrete and Water Saturated Concrete	Temperature range A ²	Characteristic bond strength in cracked concrete	$\tau_{k,cr}$	psi (MPa)	1,280 (8.8)	1,270 (8.7)	1,260 (8.7)	1,250 (8.6)	1,240 (8.6)	1,240 (8.5)	1,180 (8.1)	
		Characteristic bond strength in uncracked concrete	$\tau_{k,uncr}$	psi (MPa)	2,380 (16.4)	2,300 (15.8)	2,210 (15.3)	2,130 (14.7)	2,040 (14.1)	1,960 (13.5)	1,790 (12.4)	
	Temperature range B ²	Characteristic bond strength in cracked concrete	$\tau_{k,cr}$	psi (MPa)	880 (6.1)	870 (6.0)	870 (6.0)	860 (5.9)	860 (5.9)	850 (5.9)	810 (5.6)	
		Characteristic bond strength in uncracked concrete	$\tau_{k,uncr}$	psi (MPa)	1,640 (11.3)	1,590 (10.9)	1,530 (10.5)	1,470 (10.1)	1,410 (9.7)	1,350 (9.3)	1,240 (8.5)	
	Anchor Category			-	-	1	1	1	1	1	1	1
	Strength Reduction factor			ϕ_d, ϕ_{ws}	ϕ_s, ϕ_{ws}	0.65	0.65	0.65	0.65	0.65	0.65	0.65
Water-filled hole	Temperature range A ²	Characteristic bond strength in cracked concrete	$\tau_{k,cr}$	psi (MPa)	940 (6.5)	940 (6.5)	940 (6.5)	940 (6.5)	940 (6.5)	950 (6.5)	920 (6.4)	
		Characteristic bond strength in uncracked concrete	$\tau_{k,uncr}$	psi (MPa)	1,760 (12.1)	1,700 (11.7)	1,660 (11.4)	1,600 (11.0)	1,550 (10.7)	1,500 (10.4)	1,400 (9.7)	
	Temperature range B ²	Characteristic bond strength in cracked concrete	$\tau_{k,cr}$	psi (MPa)	650 (4.5)	650 (4.5)	650 (4.5)	650 (4.5)	650 (4.5)	650 (4.5)	640 (4.4)	
		Characteristic bond strength in uncracked concrete	$\tau_{k,uncr}$	psi (MPa)	1,210 (8.4)	1,170 (8.1)	1,140 (7.9)	1,110 (7.6)	1,070 (7.4)	1,040 (7.1)	970 (6.7)	
	Anchor Category			-	-	3	3	3	3	3	3	3
	Strength Reduction factor			ϕ_{wf}	-	0.45	0.45	0.45	0.45	0.45	0.45	0.45
Submerged concrete	Temperature range A ²	Characteristic bond strength in cracked concrete	$\tau_{k,cr}$	psi (MPa)	820 (5.7)	830 (5.7)	830 (5.8)	840 (5.8)	850 (5.9)	860 (5.9)	860 (5.9)	
		Characteristic bond strength in uncracked concrete	$\tau_{k,uncr}$	psi (MPa)	1,530 (10.6)	1,500 (10.3)	1,470 (10.1)	1,430 (9.9)	1,400 (9.6)	1,370 (9.4)	1,300 (9.0)	
	Temperature range B ²	Characteristic bond strength in cracked concrete	$\tau_{k,cr}$	psi (MPa)	570 (3.9)	570 (3.9)	580 (4.0)	580 (4.0)	590 (4.0)	590 (4.1)	590 (4.1)	
		Characteristic bond strength in uncracked concrete	$\tau_{k,uncr}$	psi (MPa)	1,060 (7.3)	1,030 (7.1)	1,010 (7.0)	990 (6.8)	960 (6.6)	940 (6.5)	900 (6.2)	
	Anchor Category			-	-	3	3	3	3	3	3	3
	Strength Reduction factor			ϕ_{UW}	-	0.45	0.45	0.45	0.45	0.45	0.45	0.45
Reduction for seismic tension			$\alpha_{N,seis}$	-	0.92	0.93	0.95	1	1	1	1	

For SI: 1 inch \equiv 25.4 mm, 1 lbf = 4.448 N, 1 psi = 0.006897 MPa.

For pound-inch units: 1 mm = 0.03937 inches, 1 N = 0.2248 lbf, 1 MPa = 145.0 psi

¹Bond strength values correspond to concrete compressive strength $f_c = 2,500$ psi (17.2 MPa). For concrete compressive strength, f_c , between 2,500 psi (17.2 MPa) and 8,000 psi (55.2 MPa), the tabulated characteristic bond strength may be increased by a factor of $(f_c / 2,500)^{0.25}$ for uncracked concrete [For SI: $(f_c / 17.2)^{0.25}$] and $(f_c / 2,500)^{0.15}$ for cracked concrete [For SI: $(f_c / 17.2)^{0.15}$]. See Section 4.1.4 of this report for bond strength determination.

²Temperature range A: Maximum short term temperature = 130°F (55°C), Maximum long term temperature = 110°F (43°C).

Temperature range B: Maximum short term temperature = 176°F (80°C), Maximum long term temperature = 110°F (43°C).

Short term elevated concrete temperatures are those that occur over brief intervals, e.g., as a result of diurnal cycling. Long term concrete temperatures are roughly constant over significant periods of time.



Fractional Threaded Rod



Bond Strength

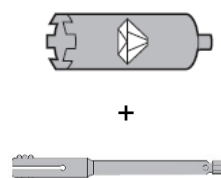

Diamond Core Bit +
Roughening Tool

TABLE 12—BOND STRENGTH DESIGN INFORMATION FOR U.S. CUSTOMARY UNIT THREADED RODS IN HOLES CORE DRILLED WITH A DIAMOND CORE BIT AND ROUGHENED WITH A HILTI ROUGHENING TOOL¹

DESIGN INFORMATION			Symbol	Units	Nominal rod diameter (in.)					
					5/8	3/4	7/8	1	1 1/4	
Minimum Embedment			$h_{ef,min}$	in. (mm)	3 1/8 (79)	3 1/2 (89)	3 1/2 (89)	4 (102)	5 (127)	
Maximum Embedment			$h_{ef,max}$	in. (mm)	12 1/2 (318)	11 1/4 (286)	17 1/2 (445)	20 (508)	25 (635)	
Dry and water saturated concrete	Temperature range A ²	Characteristic bond strength in cracked concrete	$\tau_{k,cr}$	psi (MPa)	880 (6.1)	875 (6.0)	870 (6.0)	870 (6.0)	825 (5.7)	
		Characteristic bond strength in uncracked concrete	$\tau_{k,uncr}$	psi (MPa)	2,210 (15.3)	2,130 (14.7)	2,040 (14.1)	1,960 (13.5)	1,790 (12.4)	
	Temperature range B ²	Characteristic bond strength in cracked concrete	$\tau_{k,cr}$	psi (MPa)	610 (4.2)	605 (4.2)	605 (4.2)	600 (4.1)	570 (3.9)	
		Characteristic bond strength in uncracked concrete	$\tau_{k,uncr}$	psi (MPa)	1,530 (10.5)	1,470 (10.1)	1,410 (9.7)	1,350 (9.3)	1,240 (8.5)	
	Anchor Category			-	-	1	1	1	1	1
	Strength Reduction factor			ϕ_{dt}, ϕ_{ws}	-	0.65	0.65	0.65	0.65	0.65
Reduction for seismic tension			$\alpha_{N,seis}$	-	0.95	1	1	1	1	

For SI: 1 inch \equiv 25.4 mm, 1 lbf = 4.448 N, 1 psi = 0.006897 MPa.

For pound-inch units: 1 mm = 0.03937 inches, 1 N = 0.2248 lbf, 1 MPa = 145.0 psi

¹Bond strength values correspond to concrete compressive strength in the range 2,500 psi $\leq f_c \leq$ 8,000 psi.

²Temperature range A: Maximum short term temperature = 130°F (55°C), Maximum long term temperature = 110°F (43°C).

Temperature range B: Maximum short term temperature = 176°F (80°C), Maximum long term temperature = 110°F (43°C).

Short term elevated concrete temperatures are those that occur over brief intervals, e.g., as a result of diurnal cycling. Long term concrete temperatures are roughly constant over significant periods of time.



Fractional Threaded Rod

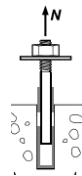

Bond Strength



Diamond Core Bit

TABLE 13—BOND STRENGTH DESIGN INFORMATION FOR FRACTIONAL THREADED RODS IN HOLES CORE DRILLED WITH A DIAMOND CORE BIT¹

DESIGN INFORMATION			Symbol	Units	Nominal rod diameter (in.)						
					3/8	1/2	5/8	3/4	7/8	1	1 1/4
Minimum Embedment			$h_{ef,min}$	in. (mm)	2 7/8 (60)	2 3/4 (70)	3 1/8 (79)	3 1/2 (89)	3 1/2 (89)	4 (102)	5 (127)
Maximum Embedment			$h_{ef,max}$	in. (mm)	7 1/2 (191)	10 (254)	12 1/2 (318)	15 (381)	17 1/2 (445)	20 (508)	25 (635)
Dry concrete and water saturated concrete	Temperature range A ²	Characteristic bond strength in uncracked concrete	$\tau_{k,uncr}$	psi (MPa)	1,550 (10.7)	1,550 (10.7)	1,550 (10.7)	1,550 (10.7)	1,550 (10.7)	1,550 (10.7)	1,550 (10.7)
		Characteristic bond strength in uncracked concrete	$\tau_{k,uncr}$	psi (MPa)	1,070 (7.4)	1,070 (7.4)	1,070 (7.4)	1,070 (7.4)	1,070 (7.4)	1,070 (7.4)	1,070 (7.4)
	Anchor Category			-	-	2	2	3	3	3	3
	Strength Reduction factor			ϕ_{dt}, ϕ_{ws}	-	0.55	0.55	0.45	0.45	0.45	0.45

For SI: 1 inch \equiv 25.4 mm, 1 lbf = 4.448 N, 1 psi = 0.006897 MPa.

For pound-inch units: 1 mm = 0.03937 inches, 1 N = 0.2248 lbf, 1 MPa = 145.0 psi

¹Bond strength values correspond to concrete compressive strength $f_c =$ 2,500 psi (17.2 MPa). For concrete compressive strength, f_c , between 2,500 psi (17.2 MPa) and 8,000 psi (55.2 MPa), the tabulated characteristic bond strength may be increased by a factor of $(f_c / 2,500)^{0.25}$ for uncracked concrete [For SI: $(f_c / 17.2)^{0.25}$]. See Section 4.1.4 of this report for bond strength determination.

²Temperature range A: Maximum short term temperature = 130°F (55°C), Maximum long term temperature = 110°F (43°C).

Temperature range B: Maximum short term temperature = 176°F (80°C), Maximum long term temperature = 110°F (43°C).

Short term elevated concrete temperatures are those that occur over brief intervals, e.g., as a result of diurnal cycling. Long term concrete temperatures are roughly constant over significant periods of time.

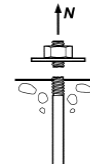

Metric Threaded Rod and EU Metric Reinforcing Bars

Steel Strength

TABLE 14—STEEL DESIGN INFORMATION FOR METRIC THREADED ROD AND EU METRIC REINFORCING BARS

DESIGN INFORMATION		Symbol	Units	Nominal rod diameter (mm) ¹								
				8	10	12	16	20	24	27	30	
Rod Outside Diameter		<i>d</i>	mm (in.)	8 (0.31)	10 (0.39)	12 (0.47)	16 (0.63)	20 (0.79)	24 (0.94)	27 (1.06)	30 (1.18)	
Rod effective cross-sectional area		<i>A_{se}</i>	mm ² (in. ²)	36.6 (0.057)	58.0 (0.090)	84.3 (0.131)	157 (0.243)	245 (0.380)	353 (0.547)	459 (0.711)	561 (0.870)	
ISO 898-1 Class 5.8	Nominal strength as governed by steel strength	<i>N_{sa}</i>	kN (lb)	18.3 (4,114)	29.0 (6,519)	42.0 (9,476)	78.5 (17,647)	122.5 (27,539)	176.5 (39,679)	229.5 (51,594)	280.5 (63,059)	
		<i>V_{sa}</i>	kN (lb)	11.0 (2,648)	14.5 (3,260)	25.5 (5,685)	47.0 (10,588)	73.5 (16,523)	106.0 (23,807)	137.5 (30,956)	168.5 (37,835)	
	Reduction for seismic shear	<i>α_{V,seis}</i>	-	1.00								
	Strength reduction factor for tension ²	<i>φ</i>	-	0.65								
	Strength reduction factor for shear ²	<i>φ</i>	-	0.60								
ISO 898-1 Class 8.8	Nominal strength as governed by steel strength	<i>N_{sa}</i>	kN (lb)	29.3 (6,582)	46.5 (10,431)	67.5 (15,161)	125.5 (28,236)	196.0 (44,063)	282.5 (63,486)	367.0 (82,550)	449.0 (100,894)	
		<i>V_{sa}</i>	kN (lb)	17.6 (3,949)	23.0 (5,216)	40.5 (9,097)	75.5 (16,942)	117.5 (26,438)	169.5 (38,092)	220.5 (49,530)	269.5 (60,537)	
	Reduction for seismic shear	<i>α_{V,seis}</i>	-	1.00								
	Strength reduction factor for tension ²	<i>φ</i>	-	0.65								
	Strength reduction factor for shear ²	<i>φ</i>	-	0.60								
ISO 3506-1 Class A4 Stainless ³	Nominal strength as governed by steel strength	<i>N_{sa}</i>	kN (lb)	25.6 (5,760)	40.6 (9,127)	59.0 (13,266)	109.9 (24,706)	171.5 (38,555)	247.1 (55,550)	229.5 (51,594)	280.5 (63,059)	
		<i>V_{sa}</i>	kN (lb)	15.4 (3,456)	20.3 (4,564)	35.4 (7,960)	65.9 (14,824)	102.9 (23,133)	148.3 (33,330)	137.7 (30,956)	168.3 (37,835)	
	Reduction for seismic shear	<i>α_{V,seis}</i>	-	0.80								
	Strength reduction factor for tension ²	<i>φ</i>	-	0.65								
	Strength reduction factor for shear ²	<i>φ</i>	-	0.60								
DESIGN INFORMATION		Symbol	Units	Nominal reinforcing bar diameter (mm)								
Nominal bar diameter		<i>d</i>	mm (in.)	10.0 (0.394)	12.0 (0.472)	14.0 (0.551)	16.0 (0.630)	20.0 (0.787)	25.0 (0.984)	28.0 (1.102)	30.0 (1.224)	32.0 (1.260)
Bar effective cross-sectional area		<i>A_{se}</i>	mm ² (in. ²)	78.5 (0.122)	113.1 (0.175)	153.9 (0.239)	201.1 (0.312)	314.2 (0.487)	490.9 (0.761)	615.8 (0.954)	706.9 (1.096)	804.2 (1.247)
DIN 488 BST 550/500	Nominal strength as governed by steel strength	<i>N_{sa}</i>	kN (lb)	43.0 (9,711)	62.0 (13,984)	84.5 (19,034)	110.5 (24,860)	173.0 (38,844)	270.0 (60,694)	338.5 (76,135)	388.8 (87,406)	442.5 (99,441)
		<i>V_{sa}</i>	kN (lb)	26.0 (5,827)	37.5 (8,390)	51.0 (11,420)	66.5 (14,916)	103.0 (23,307)	162.0 (36,416)	203.0 (45,681)	233.3 (52,444)	265.5 (59,665)
	Reduction for seismic shear	<i>α_{V,seis}</i>	-	0.70								
	Strength reduction factor for tension ²	<i>φ</i>	-	0.65								
	Strength reduction factor for shear ²	<i>φ</i>	-	0.60								

¹ Values provided for common rod and rebar material types are based on specified strengths and calculated in accordance with ACI 318-19 Eq. (17.6.1.2) and Eq. (17.7.1.2b), ACI 318-14 Eq (17.4.1.2) or Eq (17.5.1.2b) or ACI 318-11 Eq. (D-2) and Eq. (D-29), as applicable. Nuts and washers must be appropriate for the rod.

² For use with the load combinations of Section 1605.1 of the 2021 IBC or Section 1605.2 of the 2018, 2015, and 2012 IBC, ACI 318 (-19 or -14) 5.3, or ACI 318-11 9.2, as applicable, as set forth in ACI 318-19 17.5.3, ACI 318-14 17.3.3 or ACI 318 D.4.3, as applicable. If the load combinations of ACI 318-11 Appendix C are used, the appropriate value of *φ* must be determined in accordance with ACI 318-11 D.4.4. Values correspond to a brittle steel element.

³ A4-70 Stainless (M8- M24); A4-502 Stainless (M27- M30)



Metric Threaded Rod and EU Metric Reinforcing Bars

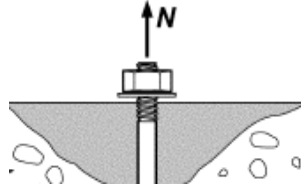

Concrete Breakout Strength

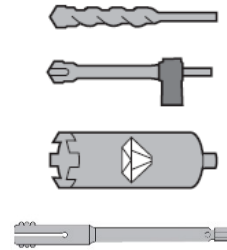

Carbide Bit or Hilti Hollow Carbide Bit
Diamond Core Bit + Roughening Tool, or Diamond Core Bit

TABLE 15—CONCRETE BREAKOUT DESIGN INFORMATION FOR METRIC THREADED ROD AND EU METRIC REINFORCING BARS ALL DRILLING METHODS¹

DESIGN INFORMATION	Symbol	Units	Nominal rod diameter (mm)								
			8	10	12	16	20	24	27	30	
Minimum Embedment	$h_{ef,min}$	mm (in.)	60 (2.4)	60 (2.4)	70 (2.8)	80 (3.1)	90 (3.5)	100 (3.9)	110 (4.3)	120 (4.7)	
Maximum Embedment	$h_{ef,max}$	mm (in.)	160 (6.3)	200 (7.9)	240 (9.4)	320 (12.6)	400 (15.7)	480 (18.9)	540 (21.4)	600 (23.7)	
Min. anchor spacing ³	s_{min}	mm (in.)	40 (1.6)	50 (2.0)	60 (2.4)	80 (3.2)	100 (3.9)	120 (4.7)	135 (5.3)	150 (5.9)	
Min. edge distance ³	c_{min}	-	5d; or see Section 4.1.9 of this report for design with reduced minimum edge distances								
Minimum concrete thickness	h_{min}	mm (in.)	$h_{ef} + 30$ $(h_{ef} + 1\frac{1}{4})$			$h_{ef} + 2d_o^{(4)}$					
DESIGN INFORMATION	Symbol	Units	Nominal reinforcing bar diameter (mm)								
			10	12	14	16	20	25	28	30	32
Minimum Embedment	$h_{ef,min}$	mm (in.)	60 (2.4)	70 (2.8)	80 (3.1)	80 (3.1)	90 (3.5)	100 (3.9)	112 (4.4)	120 (4.7)	128 (5.0)
Maximum Embedment	$h_{ef,max}$	mm (in.)	200 (7.9)	240 (9.4)	280 (11.0)	320 (12.6)	400 (15.7)	500 (19.7)	560 (22.0)	600 (23.7)	640 (25.2)
Min. anchor spacing ³	s_{min}	mm (in.)	50 (2.0)	60 (2.4)	70 (2.8)	80 (3.2)	100 (3.9)	125 (4.9)	140 (5.5)	150 (5.9)	160 (6.3)
Min. edge distance ³	c_{min}	-	5d; or see Section 4.1.9 of this report for design with reduced minimum edge distances								
Minimum concrete thickness	h_{min}	mm (in.)	$h_{ef} + 30$ $(h_{ef} + 1\frac{1}{4})$			$h_{ef} + 2d_o^{(4)}$					
Critical edge distance – splitting (for uncracked concrete)	c_{ac}	-	See Section 4.1.10 of this report.								
Effectiveness factor for cracked concrete	$k_{c,cr}$	SI (in-lb)	7.1 (17)								
Effectiveness factor for uncracked concrete	$k_{c,uncr}$	SI (in-lb)	10 (24)								
Strength reduction factor for tension, concrete failure modes ²	ϕ	-	0.65								
Strength reduction factor for shear, concrete failure modes ²	ϕ	-	0.70								

For SI: 1 inch ≅ 25.4 mm, 1 lbf = 4.448 N, 1 psi = 0.006897 MPa.

For pound-inch units: 1 mm = 0.03937 inches, 1 N = 0.2248 lbf, 1 MPa = 145.0 psi

¹Additional setting information is described in Figure 8A and 8B, Manufacturers Printed Installation Instructions (MPII).

²The strength reduction factor applies when the load combinations from the IBC or ACI 318 are used and the requirements of ACI 318-19 17.5.3, ACI 318-14 17.3.3 or ACI 318-11 D.4.3, as applicable, are met. If the load combinations of ACI 318-11 Appendix C are used, the appropriate strength reduction factor must be determined in accordance with ACI 318-11 D.4.4.

³For installations with 1³/₄-inch edge distance, refer to Section 4.1.9 for spacing and maximum torque requirements.

⁴ d_o = hole diameter.

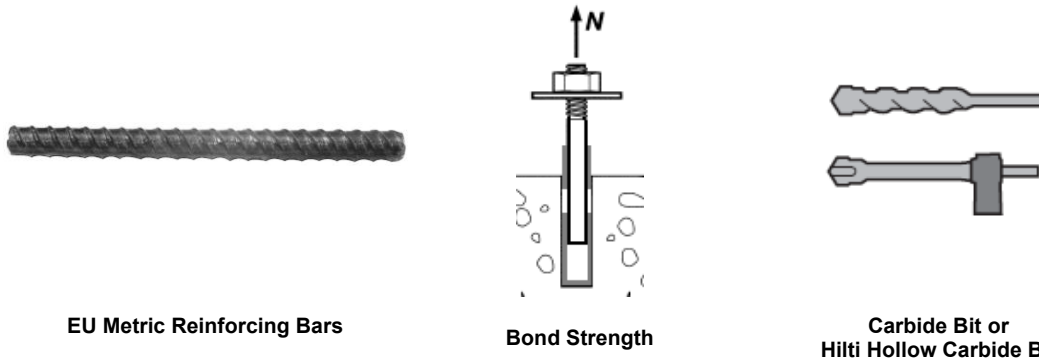

EU Metric Reinforcing Bars

Bond Strength

Carbide Bit or Hilti Hollow Carbide Bit

TABLE 16—BOND STRENGTH DESIGN INFORMATION FOR EU METRIC REINFORCING BARS IN HOLES DRILLED WITH A HAMMER DRILL AND CARBIDE BIT (OR HILTI HOLLOW CARBIDE DRILL BIT)¹

DESIGN INFORMATION			Symbol	Units	Nominal reinforcing bar diameter (mm)								
					10	12	14	16	20	25	28	30	32
Minimum Embedment			$h_{ef,min}$	mm (in.)	60 (2.4)	70 (2.8)	80 (3.1)	80 (3.1)	90 (3.5)	100 (3.9)	112 (4.4)	120 (4.7)	128 (5.0)
Maximum Embedment			$h_{ef,max}$	mm (in.)	200 (7.9)	240 (9.4)	280 (11.0)	320 (12.6)	400 (15.7)	500 (19.7)	560 (22.0)	600 (23.7)	640 (25.2)
Dry concrete and Water saturated concrete	Temperature range A ²	Characteristic bond strength in cracked concrete	$\tau_{k,cr}$	MPa (psi)	9.3 (1,350)	9.4 (1,360)	9.5 (1,380)	9.6 (1,390)	9.7 (1,410)	9.8 (1,420)	9.7 (1,400)	9.5 (1,370)	9.3 (1,350)
		Characteristic bond strength in uncracked concrete	$\tau_{k,uncr}$	MPa (psi)	12.2 (1,770)	12.1 (1,750)	12.0 (1,730)	11.8 (1,720)	11.6 (1,690)	11.4 (1,650)	11.2 (1,620)	11.1 (1,610)	11.0 (1,590)
	Temperature range B ²	Characteristic bond strength in cracked concrete	$\tau_{k,cr}$	MPa (psi)	6.4 (930)	6.5 (940)	6.5 (950)	6.6 (960)	6.7 (970)	6.8 (980)	6.7 (970)	6.5 (950)	6.4 (930)
		Characteristic bond strength in uncracked concrete	$\tau_{k,uncr}$	MPa (psi)	8.4 (1,220)	8.3 (1,210)	8.3 (1,200)	8.2 (1,190)	8.0 (1,160)	7.8 (1,140)	7.7 (1,120)	7.7 (1,110)	7.6 (1,100)
Anchor Category			-		1	1	1	1	1	1	1	1	1
Strength Reduction factor			ϕ_d, ϕ_{ws}		0.65	0.65	0.65	0.65	0.65	0.65	0.65	0.65	0.65
Water-filled hole	Temperature range A ²	Characteristic bond strength in cracked concrete	$\tau_{k,cr}$	MPa (psi)	6.9 (1,000)	6.9 (1,010)	7.0 (1,020)	7.2 (1,040)	7.4 (1,070)	7.4 (1,080)	7.4 (1,080)	7.4 (1,070)	7.2 (1,050)
		Characteristic bond strength in uncracked concrete	$\tau_{k,uncr}$	MPa (psi)	9.0 (1,310)	8.9 (1,300)	8.9 (1,280)	8.9 (1,280)	8.8 (1,270)	8.7 (1,250)	8.6 (1,250)	8.6 (1,250)	8.6 (1,240)
	Temperature range B ²	Characteristic bond strength in cracked concrete	$\tau_{k,cr}$	MPa (psi)	4.7 (690)	4.8 (700)	4.8 (700)	5.0 (720)	5.1 (740)	5.1 (740)	5.1 (740)	5.1 (740)	5.0 (720)
		Characteristic bond strength in uncracked concrete	$\tau_{k,uncr}$	MPa (psi)	6.2 (900)	6.2 (890)	6.1 (890)	6.1 (890)	6.1 (880)	6.0 (870)	5.9 (860)	5.9 (860)	5.9 (860)
Anchor Category			-	-	3	3	3	3	3	3	3	3	3
Strength Reduction factor			ϕ_{wf}	-	0.45	0.45	0.45	0.45	0.45	0.45	0.45	0.45	0.45
Submerged concrete	Temperature range A ²	Characteristic bond strength in cracked concrete	$\tau_{k,cr}$	MPa (psi)	6.0 (880)	6.1 (890)	6.2 (890)	6.3 (920)	6.6 (960)	6.8 (980)	6.8 (980)	6.8 (990)	6.8 (980)
		Characteristic bond strength in uncracked concrete	$\tau_{k,uncr}$	MPa (psi)	7.9 (1,140)	7.8 (1,140)	7.8 (1,130)	7.8 (1,140)	7.9 (1,140)	7.8 (1,140)	7.9 (1,140)	8.0 (1,150)	8.0 (1,160)
	Temperature range B ²	Characteristic bond strength in cracked concrete	$\tau_{k,cr}$	MPa (psi)	4.2 (600)	4.2 (610)	4.3 (620)	4.4 (630)	4.6 (660)	4.7 (680)	4.7 (680)	4.7 (680)	4.7 (680)
		Characteristic bond strength in uncracked concrete	$\tau_{k,uncr}$	MPa (psi)	5.4 (790)	5.4 (780)	5.4 (780)	5.4 (790)	5.4 (790)	5.4 (780)	5.4 (790)	5.5 (800)	5.5 (800)
Anchor Category			-	-	3	3	3	3	3	3	3	3	3
Strength Reduction factor			ϕ_{uw}	-	0.45	0.45	0.45	0.45	0.45	0.45	0.45	0.45	0.45
Reduction for seismic tension			$\alpha_{N,seis}$	-	0.9	0.9	0.9	0.9	0.9	0.9	0.9	0.9	0.9

For SI: 1 inch ≅ 25.4 mm, 1 lbf = 4.448 N, 1 psi = 0.006897 MPa.

For pound-inch units: 1 mm = 0.03937 inches, 1 N = 0.2248 lbf, 1 MPa = 145.0 psi

¹Bond strength values correspond to concrete compressive strength $f'_c = 2,500$ psi (17.2 MPa). For concrete compressive strength, f'_c , between 2,500 psi (17.2 MPa) and 8,000 psi (55.2 MPa), the tabulated characteristic bond strength may be increased by a factor of $(f'_c / 2,500)^{0.25}$ for uncracked concrete [For SI: $(f'_c / 17.2)^{0.25}$] and $(f'_c / 2,500)^{0.15}$ for cracked concrete [For SI: $(f'_c / 17.2)^{0.15}$]. See Section 4.1.4 of this report for bond strength determination.

²Temperature range A: Maximum short term temperature = 130°F (55°C), Maximum long term temperature = 110°F (43°C).

Temperature range B: Maximum short term temperature = 176°F (80°C), Maximum long term temperature = 110°F (43°C).

Short term elevated concrete temperatures are those that occur over brief intervals, e.g., as a result of diurnal cycling. Long term concrete temperatures are roughly constant over significant periods of time.



EU Metric Reinforcing Bars

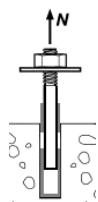

Bond Strength

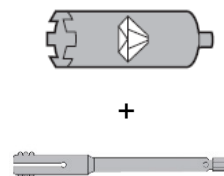

Diamond Core Bit +
Roughening Tool

TABLE 17—BOND STRENGTH DESIGN INFORMATION FOR EU METRIC REINFORCING BARS IN HOLES
CORE DRILLED WITH A DIAMOND CORE BIT AND ROUGHENED WITH A HILTI ROUGHENING TOOL¹

DESIGN INFORMATION			Symbol	Units	Nominal reinforcing bar diameter (mm)					
					14	16	20	25	28	
Minimum Embedment			$h_{ef,min}$	mm (in.)	80 (3.1)	80 (3.1)	90 (3.5)	100 (3.9)	112 (4.4)	
Maximum Embedment			$h_{ef,max}$	mm (in.)	280 (11.0)	320 (12.6)	400 (15.7)	500 (19.7)	560 (22.0)	
Dry and water saturated concrete	Temperature range A ²	Characteristic bond strength in cracked concrete	$\tau_{k,cr}$	MPa (psi)	6.7 (965)	6.7 (970)	6.8 (985)	6.9 (995)	6.8 (980)	
		Characteristic bond strength in uncracked concrete	$\tau_{k,uncr}$	MPa (psi)	12.0 (1,730)	11.8 (1,720)	11.6 (1,690)	11.4 (1,650)	11.2 (1,620)	
	Temperature range B ²	Characteristic bond strength in cracked concrete	$\tau_{k,cr}$	MPa (psi)	4.6 (665)	4.6 (670)	4.7 (680)	4.8 (685)	4.7 (680)	
		Characteristic bond strength in uncracked concrete	$\tau_{k,uncr}$	MPa (psi)	8.3 (1,200)	8.2 (1,190)	8.0 (1,160)	7.8 (1,140)	7.7 (1,120)	
	Anchor Category			-	-	1	1	1	1	1
	Strength Reduction factor			ϕ_d, ϕ_{ws}	-	0.65	0.65	0.65	0.65	0.65
Reduction for seismic tension			$\alpha_{N,seis}$	-	0.9	0.9	0.9	0.9	0.9	

For SI: 1 inch \equiv 25.4 mm, 1 lbf = 4.448 N, 1 psi = 0.006897 MPa.

For pound-inch units: 1 mm = 0.03937 inches, 1 N = 0.2248 lbf, 1 MPa = 145.0 psi

¹Bond strength values correspond to concrete compressive strength in the range 2,500 psi \leq $f'_c \leq$ 8,000 psi).

²Temperature range A: Maximum short term temperature = 130°F (55°C), Maximum long term temperature = 110°F (43°C).

Temperature range B: Maximum short term temperature = 176°F (80°C), Maximum long term temperature = 110°F (43°C).

Short term elevated concrete temperatures are those that occur over brief intervals, e.g., as a result of diurnal cycling. Long term concrete temperatures are roughly constant over significant periods of time.



EU Metric Reinforcing Bars

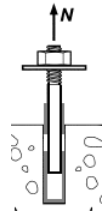

Bond Strength



Diamond Core Bit

TABLE 18—BOND STRENGTH DESIGN INFORMATION FOR EU METRIC REINFORCING BARS IN HOLES CORE DRILLED WITH A DIAMOND CORE BIT¹

DESIGN INFORMATION			Symbol	Units	Nominal reinforcing bar diameter (mm)									
					10	12	14	16	20	25	28	30	32	
Minimum Embedment			$h_{ef,min}$	mm (in.)	60 (2.4)	70 (2.8)	80 (3.1)	80 (3.1)	90 (3.5)	100 (3.9)	112 (4.4)	120 (4.7)	128 (5.0)	
Maximum Embedment			$h_{ef,max}$	mm (in.)	200 (7.9)	240 (9.4)	280 (11.0)	320 (12.6)	400 (15.7)	500 (19.7)	560 (22.0)	600 (23.7)	640 (25.2)	
Dry and Water Saturated concrete	Temperature range A ²	Characteristic bond strength in uncracked concrete	$\tau_{k,uncr}$	MPa (psi)	8.0 (1,150)	8.0 (1,150)	8.0 (1,150)	8.0 (1,150)	8.0 (1,150)	8.0 (1,150)	8.0 (1,150)	8.0 (1,150)	8.0 (1,150)	
	Temperature range B ²	Characteristic bond strength in uncracked concrete	$\tau_{k,uncr}$	MPa (psi)	5.5 (800)	5.5 (800)	5.5 (800)	5.5 (800)	5.5 (800)	5.5 (800)	5.5 (800)	5.5 (800)	5.5 (800)	
	Anchor Category		-	-		2	2	2	3	3	3	3	3	3
	Strength Reduction factor		ϕ_d, ϕ_{vs}			0.55	0.55	0.55	0.45	0.45	0.45	0.45	0.45	0.45

For SI: 1 inch ≅ 25.4 mm, 1 lbf = 4.448 N, 1 psi = 0.006897 MPa.

For pound-inch units: 1 mm = 0.03937 inches, 1 N = 0.2248 lbf, 1 MPa = 145.0 psi

¹Bond strength values correspond to concrete compressive strength $f'_c = 2,500$ psi (17.2 MPa). For concrete compressive strength, f'_c , between 2,500 psi (17.2 MPa) and 8,000 psi (55.2 MPa), the tabulated characteristic bond strength may be increased by a factor of $(f'_c / 2,500)^{0.25}$ for uncracked concrete [For SI: $(f'_c / 17.2)^{0.25}$]. See Section 4.1.4 of this report for bond strength determination.

²Temperature range A: Maximum short term temperature = 130°F (55°C), Maximum long term temperature = 110°F (43°C).

Temperature range B: Maximum short term temperature = 176°F (80°C), Maximum long term temperature = 110°F (43°C).

Short term elevated concrete temperatures are those that occur over brief intervals, e.g., as a result of diurnal cycling. Long term concrete temperatures are roughly constant over significant periods of time.



Metric Threaded Rod

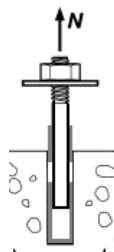

Bond Strength

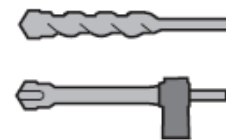

Carbide Bit or Hilti Hollow Carbide Bit

TABLE 19—BOND STRENGTH DESIGN INFORMATION FOR METRIC THREADED RODS IN HOLES DRILLED WITH A HAMMER DRILL AND CARBIDE BIT (OR HILTI HOLLOW CARBIDE DRILL BIT)¹

DESIGN INFORMATION			Symbol	Units	Nominal rod diameter (mm)								
					8	10	12	16	20	24	27	30	
Minimum Embedment			$h_{ef,min}$	mm (in.)	60 (2.4)	60 (2.4)	70 (2.8)	80 (3.1)	90 (3.5)	100 (3.9)	110 (4.3)	120 (4.7)	
Maximum Embedment			$h_{ef,max}$	mm (in.)	160 (6.3)	200 (7.9)	240 (9.4)	320 (12.6)	400 (15.7)	480 (18.9)	540 (21.4)	600 (23.7)	
Dry and Water Saturated Concrete	Temperature range A ²	Characteristic bond strength in cracked concrete	$\tau_{k,cr}$	MPa (psi)	8.8 (1,280)	8.8 (1,280)	8.8 (1,270)	8.7 (1,260)	8.6 (1,250)	8.5 (1,240)	8.5 (1,230)	8.4 (1,220)	
		Characteristic bond strength in uncracked concrete	$\tau_{k,uncr}$	MPa (psi)	16.7 (2,420)	16.3 (2,370)	16.0 (2,320)	15.2 (2,210)	14.5 (2,100)	13.8 (2,000)	13.2 (1,920)	12.7 (1,840)	
	Temperature range B ²	Characteristic bond strength in cracked concrete	$\tau_{k,cr}$	MPa (psi)	6.1 (890)	6.1 (880)	6.0 (880)	6.0 (870)	5.9 (860)	5.9 (860)	5.9 (850)	5.8 (840)	
		Characteristic bond strength in uncracked concrete	$\tau_{k,uncr}$	MPa (psi)	11.5 (1,670)	11.3 (1,630)	11.0 (1,600)	10.5 (1,520)	10.0 (1,450)	9.5 (1,380)	9.1 (1,320)	8.7 (1,270)	
	Anchor Category			-	-	1	1	1	1	1	1	1	1
	Strength Reduction factor			ϕ_{dt}, ϕ_{ws}	-	0.65	0.65	0.65	0.65	0.65	0.65	0.65	0.65
Water-filled hole	Temperature range A ²	Characteristic bond strength in cracked concrete	$\tau_{k,cr}$	MPa (psi)	6.5 (940)	6.5 (940)	6.5 (940)	6.5 (940)	6.5 (940)	6.5 (940)	6.5 (950)	6.5 (950)	
		Characteristic bond strength in uncracked concrete	$\tau_{k,uncr}$	MPa (psi)	12.3 (1,780)	12.1 (1,750)	11.8 (1,710)	11.4 (1,650)	11.0 (1,590)	10.5 (1,520)	10.2 (1,470)	9.8 (1,430)	
	Temperature range B ²	Characteristic bond strength in cracked concrete	$\tau_{k,cr}$	MPa (psi)	4.5 (650)	4.5 (650)	4.5 (650)	4.5 (650)	4.5 (650)	4.5 (650)	4.5 (650)	4.5 (650)	
		Characteristic bond strength in uncracked concrete	$\tau_{k,uncr}$	MPa (psi)	8.5 (1,230)	8.3 (1,210)	8.2 (1,180)	7.9 (1,140)	7.6 (1,100)	7.2 (1,050)	7.0 (1,020)	6.8 (990)	
	Anchor Category			-	-	3	3	3	3	3	3	3	3
	Strength Reduction factor			ϕ_{wf}	-	0.45	0.45	0.45	0.45	0.45	0.45	0.45	0.45
Submerged concrete	Temperature range A ²	Characteristic bond strength in cracked concrete	$\tau_{k,cr}$	MPa (psi)	5.7 (820)	5.7 (820)	5.7 (830)	5.7 (830)	5.8 (840)	5.9 (860)	6.0 (870)	6.0 (870)	
		Characteristic bond strength in uncracked concrete	$\tau_{k,uncr}$	MPa (psi)	10.7 (1,550)	10.5 (1,530)	10.4 (1,500)	10.1 (1,460)	9.8 (1,420)	9.5 (1,380)	9.3 (1,350)	9.1 (1,320)	
	Temperature range B ²	Characteristic bond strength in cracked concrete	$\tau_{k,cr}$	MPa (psi)	3.9 (570)	3.9 (570)	3.9 (570)	4.0 (580)	4.0 (580)	4.1 (590)	4.1 (600)	4.2 (600)	
		Characteristic bond strength in uncracked concrete	$\tau_{k,uncr}$	MPa (psi)	7.4 (1,070)	7.3 (1,060)	7.2 (1,040)	7.0 (1,010)	6.8 (980)	6.6 (950)	6.4 (930)	6.3 (910)	
	Anchor Category			-	-	3	3	3	3	3	3	3	3
	Strength Reduction factor			ϕ_{uw}	-	0.45	0.45	0.45	0.45	0.45	0.45	0.45	0.45
Reduction for seismic tension			$\alpha_{N,seis}$	-	1	0.92	0.93	0.95	1	1	1	1	

For SI: 1 inch \approx 25.4 mm, 1 lbf = 4.448 N, 1 psi = 0.006897 MPa.

For pound-inch units: 1 mm = 0.03937 inches, 1 N = 0.2248 lbf, 1 MPa = 145.0 psi

¹Bond strength values correspond to concrete compressive strength $f'_c = 2,500$ psi (17.2 MPa). For concrete compressive strength, f'_c , between 2,500 psi (17.2 MPa) and 8,000 psi (55.2 MPa), the tabulated characteristic bond strength may be increased by a factor of $(f'_c / 2,500)^{0.25}$ for uncracked concrete [For SI: $(f'_c / 17.2)^{0.25}$] and $(f'_c / 2,500)^{0.15}$ for cracked concrete [For SI: $(f'_c / 17.2)^{0.15}$]. See Section 4.1.4 of this report for bond strength determination.

²Temperature range A: Maximum short term temperature = 130°F (55°C), Maximum long term temperature = 110°F (43°C).

Temperature range B: Maximum short term temperature = 176°F (80°C), Maximum long term temperature = 110°F (43°C).

Short term elevated concrete temperatures are those that occur over brief intervals, e.g., as a result of diurnal cycling. Long term concrete temperatures are roughly constant over significant periods of time.



Metric Threaded Rod

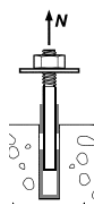

Bond Strength

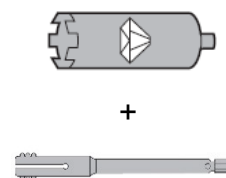

Diamond Core Bit + Roughening Tool

TABLE 20—BOND STRENGTH DESIGN INFORMATION FOR METRIC THREADED RODS IN HOLES CORE DRILLED WITH A DIAMOND CORE BIT AND ROUGHENED WITH A HILTI ROUGHENING TOOL¹

DESIGN INFORMATION			Symbol	Units	Nominal rod diameter (mm)					
					16	20	24	27	30	
Minimum Embedment			$h_{ef,min}$	mm (in.)	80 (3.1)	90 (3.5)	100 (3.9)	110 (4.3)	120 (4.7)	
Maximum Embedment			$h_{ef,max}$	mm (in.)	320 (12.6)	400 (15.7)	480 (18.9)	540 (21.4)	600 (23.7)	
Dry and water saturated concrete	Temp. range A ²	Characteristic bond strength in cracked concrete	$\tau_{k,cr}$	MPa (psi)	6.1 (880)	6.0 (875)	6.0 (870)	6.0 (860)	5.9 (855)	
		Characteristic bond strength in uncracked concrete	$\tau_{k,uncr}$	Mpa (psi)	15.2 (2,210)	14.5 (2,100)	13.8 (2,000)	13.2 (1,920)	12.7 (1,840)	
	Temp. range B ²	Characteristic bond strength in cracked concrete	$\tau_{k,cr}$	MPa (psi)	4.2 (610)	4.2 (605)	4.2 (600)	4.2 (595)	4.1 (590)	
		Characteristic bond strength in uncracked concrete	$\tau_{k,uncr}$	MPa (psi)	10.5 (1,520)	10.0 (1,450)	9.5 (1,385)	9.1 (1,320)	8.7 (1,270)	
	Anchor Category			-	-	1	1	1	1	1
	Strength Reduction factor			ϕ_d, ϕ_{ws}	-	0.65	0.65	0.65	0.65	0.65
Reduction for seismic tension			$\alpha_{N,seis}$	-	0.95	1	1	1	1	

For SI: 1 inch ≡ 25.4 mm, 1 lbf = 4.448 N, 1 psi = 0.006897 MPa.

For pound-inch units: 1 mm = 0.03937 inches, 1 N = 0.2248 lbf, 1 MPa = 145.0 psi

¹Bond strength values correspond to concrete compressive strength in the range 2,500 psi ≤ f'_c ≤ 8,000 psi).

²Temperature range A: Maximum short term temperature = 130°F (55°C), Maximum long term temperature = 110°F (43°C).

Temperature range B: Maximum short term temperature = 176°F (80°C), Maximum long term temperature = 110°F (43°C).

Short term elevated concrete temperatures are those that occur over brief intervals, e.g., as a result of diurnal cycling. Long term concrete temperatures are roughly constant over significant periods of time.



Metric Threaded Rod

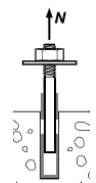

Bond Strength



Diamond Core Bit

TABLE 21—BOND STRENGTH DESIGN INFORMATION FOR METRIC THREADED RODS IN HOLES CORE DRILLED WITH A DIAMOND CORE BIT¹

DESIGN INFORMATION			Symbol	Units	Nominal rod diameter (mm)							
					8	10	12	16	20	24	27	30
Minimum Embedment			$h_{ef,min}$	mm (in.)	60 (2.4)	60 (2.4)	70 (2.8)	80 (3.1)	90 (3.5)	100 (3.9)	110 (4.3)	120 (4.7)
Maximum Embedment			$h_{ef,max}$	mm (in.)	160 (6.3)	200 (7.9)	240 (9.4)	320 (12.6)	400 (15.7)	480 (18.9)	540 (21.4)	600 (23.7)
Dry and water saturated concrete	Temp. range A ²	Characteristic bond strength in uncracked concrete	$\tau_{k,uncr}$	MPa (psi)	10.7 (1,550)	10.7 (1,550)	10.7 (1,550)	10.7 (1,550)	10.7 (1,550)	10.7 (1,550)	10.7 (1,550)	10.7 (1,550)
		Characteristic bond strength in uncracked concrete	$\tau_{k,uncr}$	MPa (psi)	7.4 (1,070)	7.4 (1,070)	7.4 (1,070)	7.4 (1,070)	7.4 (1,070)	7.4 (1,070)	7.4 (1,070)	7.4 (1,070)
	Anchor Category			-	-	2	2	2	3	3	3	3
	Strength Reduction factor			ϕ_d, ϕ_{ws}	-	0.55	0.55	0.55	0.45	0.45	0.45	0.45

For SI: 1 inch ≡ 25.4 mm, 1 lbf = 4.448 N, 1 psi = 0.006897 MPa.

For pound-inch units: 1 mm = 0.03937 inches, 1 N = 0.2248 lbf, 1 MPa = 145.0 psi

¹Bond strength values correspond to concrete compressive strength $f'_c = 2,500$ psi (17.2 MPa). For concrete compressive strength, f'_c , between 2,500 psi (17.2 MPa) and 8,000 psi (55.2 MPa), the tabulated characteristic bond strength may be increased by a factor of $(f'_c / 2,500)^{0.25}$ for uncracked concrete [For SI: $(f'_c / 17.2)^{0.25}$]. See Section 4.1.4 of this report for bond strength determination.

²Temperature range A: Maximum short term temperature = 130°F (55°C), Maximum long term temperature = 110°F (43°C).

Temperature range B: Maximum short term temperature = 176°F (80°C), Maximum long term temperature = 110°F (43°C).

Short term elevated concrete temperatures are those that occur over brief intervals, e.g., as a result of diurnal cycling. Long term concrete temperatures are roughly constant over significant periods of time.



Canadian Reinforcing Bars

Steel Strength

TABLE 22—STEEL DESIGN INFORMATION FOR CANADIAN METRIC REINFORCING BARS¹

DESIGN INFORMATION		Symbol	Units	Nominal reinforcing bar size				
				10 M	15 M	20 M	25 M	30 M
Nominal bar diameter		d	mm (in.)	11.3 (0.445)	16.0 (0.630)	19.5 (0.768)	25.2 (0.992)	29.9 (1.177)
Bar effective cross-sectional area		A_{se}	mm ² (in. ²)	100.3 (0.155)	201.1 (0.312)	298.6 (0.463)	498.8 (0.773)	702.2 (1.088)
CSA G30	Nominal strength as governed by steel strength	N_{sa}	kN (lb)	54.0 (12,175)	108.5 (24,408)	161.5 (36,255)	270.0 (60,548)	380.0 (85,239)
		V_{sa}	kN (lb)	32.5 (7,305)	65.0 (14,645)	97.0 (21,753)	161.5 (36,329)	227.5 (51,144)
	Reduction for seismic shear	$\alpha_{V,seis}$	-	0.70				
	Strength reduction factor for tension ²	ϕ	-	0.65				
	Strength reduction factor for shear ²	ϕ	-	0.60				

For SI: 1 inch \equiv 25.4 mm, 1 lbf = 4.448 N, 1 psi = 0.006897 MPa.

For pound-inch units: 1 mm = 0.03937 inches, 1 N = 0.2248 lbf, 1 MPa = 145.0 psi

¹Values provided for common rod material types based on specified strengths and calculated in accordance with ACI 318-19 Eq. (17.6.1.2) and Eq. (17.7.1.2b), ACI 318-14 Eq. (17.4.1.2) or Eq. (17.5.1.2b) or ACI 318-11 Eq. (D-2) and Eq. (D-29), as applicable. Other material specifications are admissible.

²For use with the load combinations of ACI 318 (-19 or -14) 5.3 or ACI 318-11 9.2, as applicable, as set forth in ACI 318-19 17.5.3, ACI 318-14 17.3.3 or ACI 318-11 D.4.3, as applicable.

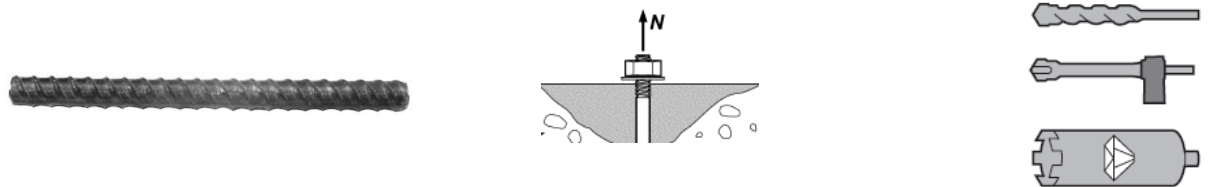

Canadian Reinforcing Bars

Concrete Breakout Strength

Carbide Bit or
Hilti Hollow Carbide Bit
or Diamond Core Bit

TABLE 23—CONCRETE BREAKOUT DESIGN INFORMATION FOR CANADIAN METRIC REINFORCING BARS IN HOLES DRILLED WITH A HAMMER DRILL AND CARBIDE BIT (OR HILTI HOLLOW CARBIDE DRILL BIT), OR DIAMOND CORE BIT¹

DESIGN INFORMATION		Symbol	Units	Nominal reinforcing bar size				
				10 M	15 M	20 M	25 M	30 M
Effectiveness factor for cracked concrete		$k_{c,cr}$	SI (in-lb)	7.1 (17)				
Effectiveness factor for uncracked concrete		$k_{c,uncr}$	SI (in-lb)	10 (24)				
Minimum Embedment		$h_{ef,min}$	mm (in.)	60 (2.4)	80 (3.1)	90 (3.5)	101 (4.0)	120 (4.7)
Maximum Embedment		$h_{ef,max}$	mm (in.)	226 (8.9)	320 (12.6)	390 (15.4)	504 (19.8)	598 (23.5)
Min. bar spacing ³		s_{min}	mm (in.)	57 (2.2)	80 (3.1)	98 (3.8)	126 (5.0)	150 (5.9)
Min. edge distance ³		c_{min}	mm (in.)	5d; or see Section 4.1.9 of this report for design with reduced minimum edge distances				
Minimum concrete thickness		h_{min}	mm (in.)	$h_{ef} + 30$ $(h_{ef} + 1\frac{1}{4})$	$h_{ef} + 2d_o^{(4)}$			
Critical edge distance – splitting (for uncracked concrete)		c_{ac}	-	See Section 4.1.10 of this report.				
Strength reduction factor for tension, concrete failure modes ²		ϕ	-	0.65				
Strength reduction factor for shear, concrete failure modes ²		ϕ	-	0.70				

For SI: 1 inch \equiv 25.4 mm, 1 lbf = 4.448 N, 1 psi = 0.006897 MPa.

For pound-inch units: 1 mm = 0.03937 inches, 1 N = 0.2248 lbf, 1 MPa = 145.0 psi

¹Additional setting information is described in Figure 8A, Manufacturers Printed Installation Instructions (MPII).

²The strength reduction factor applies when the load combinations from the IBC or ACI 318 are used and the requirements of ACI 318-19 17.5.3, ACI 318-14 17.3.3 or ACI 318-11 D.4.3, as applicable, are met. If the load combinations of ACI 318-11 Appendix C are used, the appropriate strength reduction factor must be determined in accordance with ACI 318-11 D.4.4.

³For installations with 1³/₄-inch edge distance, refer to Section 4.1.9 for spacing and maximum torque requirements.

⁴ d_o = hole diameter.



Canadian Reinforcing Bars



Bond Strength

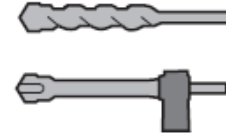

Carbide Bit or Hilti Hollow Carbide Bit

TABLE 24—BOND STRENGTH DESIGN INFORMATION FOR CANADIAN METRIC REINFORCING BARS IN HOLES DRILLED WITH A HAMMER DRILL AND CARBIDE BIT (OR HILTI HOLLOW CARBIDE DRILL BIT) ¹

DESIGN INFORMATION			Symbol	Units	Nominal reinforcing bar size					
					10M	15M	20M	25M	30M	
Minimum Embedment			$h_{ef,min}$	mm (in.)	60 (2.4)	80 (3.1)	90 (3.5)	101 (4.0)	120 (4.7)	
Maximum Embedment			$h_{ef,max}$	mm (in.)	226 (8.9)	320 (12.6)	390 (15.4)	504 (19.8)	598 (23.5)	
Dry concrete and Water Saturated Concrete	Temperature range A ²	Characteristic bond strength in cracked concrete	$\tau_{k,cr}$	MPa (psi)	9.4 (1,360)	9.6 (1,390)	9.7 (1,410)	9.8 (1,420)	9.5 (1,380)	
		Characteristic bond strength in uncracked concrete	$\tau_{k,uncr}$	MPa (psi)	12.1 (1,760)	11.8 (1,720)	11.7 (1,690)	11.3 (1,650)	11.1 (1,610)	
	Temperature range B ²	Characteristic bond strength in cracked concrete	$\tau_{k,cr}$	MPa (psi)	6.5 (940)	6.6 (960)	6.7 (970)	6.8 (980)	6.5 (950)	
		Characteristic bond strength in uncracked concrete	$\tau_{k,uncr}$	MPa (psi)	8.4 (1,210)	8.2 (1,190)	8.0 (1,170)	7.8 (1,140)	7.7 (1,110)	
	Anchor Category			-	-	1	1	1	1	1
	Strength Reduction factor			ϕ_d, ϕ_{ws}	-	0.65	0.65	0.65	0.65	0.65
Water-filled hole	Temperature range A ²	Characteristic bond strength in cracked concrete	$\tau_{k,cr}$	MPa (psi)	6.9 (1,010)	7.2 (1,040)	7.3 (1,060)	7.4 (1,080)	7.3 (1,060)	
		Characteristic bond strength in uncracked concrete	$\tau_{k,uncr}$	MPa (psi)	8.9 (1,300)	8.9 (1,280)	8.8 (1,270)	8.6 (1,250)	8.5 (1,240)	
	Temperature range B ²	Characteristic bond strength in cracked concrete	$\tau_{k,cr}$	MPa (psi)	4.8 (700)	5.0 (720)	5.0 (730)	5.1 (740)	5.0 (730)	
		Characteristic bond strength in uncracked concrete	$\tau_{k,uncr}$	MPa (psi)	6.2 (900)	6.1 (890)	6.1 (880)	6.0 (860)	5.9 (850)	
	Anchor Category			-	-	3	3	3	3	3
	Strength Reduction factor			ϕ_{wf}	-	0.45	0.45	0.45	0.45	0.45
Submerged concrete	Temperature range A ²	Characteristic bond strength in cracked concrete	$\tau_{k,cr}$	MPa (psi)	6.1 (880)	6.3 (920)	6.5 (940)	6.8 (980)	6.6 (960)	
		Characteristic bond strength in uncracked concrete	$\tau_{k,uncr}$	MPa (psi)	7.8 (1,130)	7.8 (1,140)	7.8 (1,140)	7.8 (1,140)	7.8 (1,130)	
	Temperature range B ²	Characteristic bond strength in cracked concrete	$\tau_{k,cr}$	MPa (psi)	4.2 (610)	4.4 (630)	4.5 (650)	4.7 (680)	4.6 (660)	
		Characteristic bond strength in uncracked concrete	$\tau_{k,uncr}$	MPa (psi)	5.4 (780)	5.4 (790)	5.4 (780)	5.4 (780)	5.4 (780)	
	Anchor Category			-	-	3	3	3	3	3
	Strength Reduction factor			ϕ_{uw}	-	0.45	0.45	0.45	0.45	0.45
Reduction for seismic tension			$\alpha_{N,seis}$	-	0.9	0.9	0.9	0.9	0.9	

For SI: 1 inch \equiv 25.4 mm, 1 lbf = 4.448 N, 1 psi = 0.006897 MPa.

For pound-inch units: 1 mm = 0.03937 inches, 1 N = 0.2248 lbf, 1 MPa = 145.0 psi

¹Bond strength values correspond to concrete compressive strength $f'_c = 2,500$ psi (17.2 MPa). For concrete compressive strength, f'_c , between 2,500 psi (17.2 MPa) and 8,000 psi (55.2 MPa), the tabulated characteristic bond strength may be increased by a factor of $(f'_c / 2,500)^{0.25}$ for uncracked concrete [For SI: $(f'_c / 17.2)^{0.25}$] and $(f'_c / 2,500)^{0.15}$ for cracked concrete [For SI: $(f'_c / 17.2)^{0.15}$]. See Section 4.1.4 of this report for bond strength determination.

²Temperature range A: Maximum short term temperature = 130°F (55°C), Maximum long term temperature = 110°F (43°C).

Temperature range B: Maximum short term temperature = 176°F (80°C), Maximum long term temperature = 110°F (43°C).

Short term elevated concrete temperatures are those that occur over brief intervals, e.g., as a result of diurnal cycling. Long term concrete temperatures are roughly constant over significant periods of time.



Canadian Reinforcing Bars

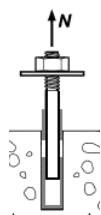

Bond Strength

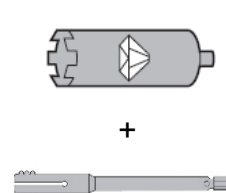

Diamond Core Bit + Roughening Tool

TABLE 25A—BOND STRENGTH DESIGN INFORMATION FOR CANADIAN METRIC REINFORCING BARS IN HOLES CORE DRILLED WITH A DIAMOND CORE BIT AND ROUGHENED WITH A HILTI ROUGHENING TOOL¹

DESIGN INFORMATION			Symbol	Units	Nominal reinforcing bar size		
					15M	20M	
Minimum Embedment			$h_{ef,min}$	mm (in.)	80 (3.1)	90 (3.5)	
Maximum Embedment			$h_{ef,max}$	mm (in.)	320 (12.6)	390 (15.4)	
Dry and Water Saturated concrete	Temperature range A ²	Characteristic bond strength in cracked concrete	$\tau_{k,cr}$	MPa (psi)	6.7 (970)	6.8 (985)	
		Characteristic bond strength in uncracked concrete	$\tau_{k,uncr}$	MPa (psi)	11.8 (1,720)	11.7 (1,690)	
	Temperature range B ²	Characteristic bond strength in cracked concrete	$\tau_{k,cr}$	MPa (psi)	4.6 (670)	4.7 (680)	
		Characteristic bond strength in uncracked concrete	$\tau_{k,uncr}$	MPa (psi)	8.2 (1,190)	8.0 (1,170)	
	Anchor Category			-	-	1	1
	Strength Reduction factor			ϕ_d, ϕ_{vs}	-	0.65	0.65
Reduction for seismic tension			$\alpha_{N,seis}$	-	0.9	0.9	

For SI: 1 inch \equiv 25.4 mm, 1 lbf = 4.448 N, 1 psi = 0.006897 MPa.

For pound-inch units: 1 mm = 0.03937 inches, 1 N = 0.2248 lbf, 1 MPa = 145.0 psi

¹Bond strength values correspond to concrete compressive strength in the range 2,500 psi $\leq f'_c \leq$ 8,000 psi.

²Temperature range A: Maximum short term temperature = 130°F (55°C), Maximum long term temperature = 110°F (43°C).

Temperature range B: Maximum short term temperature = 176°F (80°C), Maximum long term temperature = 110°F (43°C).

Short term elevated concrete temperatures are those that occur over brief intervals, e.g., as a result of diurnal cycling. Long term concrete temperatures are roughly constant over significant periods of time.



Canadian Reinforcing Bars

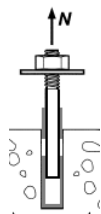

Bond Strength

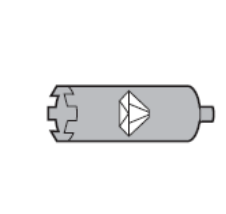

Diamond Core Bit

TABLE 25B—BOND STRENGTH DESIGN INFORMATION FOR CANADIAN METRIC REINFORCING BARS IN HOLES CORE DRILLED WITH A DIAMOND CORE BIT¹

DESIGN INFORMATION			Symbol	Units	Nominal reinforcing bar size				
					10M	15M	20M	25M	30M
Minimum Embedment			$h_{ef,min}$	mm (in.)	60 (2.4)	80 (3.1)	90 (3.5)	101 (4.0)	120 (4.7)
Maximum Embedment			$h_{ef,max}$	mm (in.)	226 (8.9)	320 (12.6)	390 (15.4)	504 (19.8)	598 (23.5)
Dry and Water Saturated concrete	Temperature range A ²	Characteristic bond strength in uncracked concrete	$\tau_{k,uncr}$	MPa (psi)	8.0 (1,150)	8.0 (1,150)	8.0 (1,150)	8.0 (1,150)	8.0 (1,150)
		Characteristic bond strength in uncracked concrete	$\tau_{k,uncr}$	MPa (psi)	5.5 (800)	5.5 (800)	5.5 (800)	5.5 (800)	5.5 (800)
	Anchor Category			-	-	2	3	3	3
	Strength Reduction factor			ϕ_d, ϕ_{vs}	-	0.55	0.45	0.45	0.45

For SI: 1 inch \equiv 25.4 mm, 1 lbf = 4.448 N, 1 psi = 0.006897 MPa.

For pound-inch units: 1 mm = 0.03937 inches, 1 N = 0.2248 lbf, 1 MPa = 145.0 psi

¹Bond strength values correspond to concrete compressive strength $f'_c =$ 2,500 psi (17.2 MPa). For concrete compressive strength, f'_c , between 2,500 psi (17.2 MPa) and 8,000 psi (55.2 MPa), the tabulated characteristic bond strength may be increased by a factor of $(f'_c / 2,500)^{0.25}$ for uncracked concrete [For SI: $(f'_c / 17.2)^{0.25}$]. See Section 4.1.4 of this report for bond strength determination.

²Temperature range A: Maximum short term temperature = 130°F (55°C), Maximum long term temperature = 110°F (43°C).

Temperature range B: Maximum short term temperature = 176°F (80°C), Maximum long term temperature = 110°F (43°C).

Short term elevated concrete temperatures are those that occur over brief intervals, e.g., as a result of diurnal cycling. Long term concrete temperatures are roughly constant over significant periods of time.

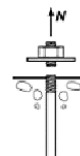

Fractional and Metric HIS-N and HIS-RN Internal Threaded Insert

Steel Strength

TABLE 26—STEEL DESIGN INFORMATION FOR FRACTIONAL AND METRIC HIS-N AND HIS-RN THREADED INSERTS¹

DESIGN INFORMATION	Symbol	Units	Nominal Bolt/Cap Screw Diameter (in.) Fractional				Units	Nominal Bolt/Cap Screw Diameter (mm) Metric					
			³ / ₈	¹ / ₂	⁵ / ₈	³ / ₄		8	10	12	16	20	
HIS Insert O.D.	<i>D</i>	in. (mm)	0.65 (16.5)	0.81 (20.5)	1.00 (25.4)	1.09 (27.6)	mm (in.)	12.5 (0.49)	16.5 (0.65)	20.5 (0.81)	25.4 (1.00)	27.6 (1.09)	
HIS insert length	<i>l</i>	in. (mm)	4.33 (110)	4.92 (125)	6.69 (170)	8.07 (205)	mm (in.)	90 (3.54)	110 (4.33)	125 (4.92)	170 (6.69)	205 (8.07)	
Bolt effective cross-sectional area	<i>A_{se}</i>	in. ² (mm ²)	0.0775 (50)	0.1419 (92)	0.2260 (146)	0.3345 (216)	mm ² (in. ²)	36.6 (0.057)	58 (0.090)	84.3 (0.131)	157 (0.243)	245 (0.380)	
HIS insert effective cross-sectional area	<i>A_{insert}</i>	in. ² (mm ²)	0.178 (115)	0.243 (157)	0.404 (260)	0.410 (265)	mm ² (in. ²)	51.5 (0.080)	108 (0.167)	169.1 (0.262)	256.1 (0.397)	237.6 (0.368)	
ASTM A193 B7	Nominal steel strength – ASTM A193 B7 ³ bolt/cap screw	<i>N_{sa}</i>	lb (kN)	9,690 (43.1)	17,740 (78.9)	28,250 (125.7)	41,815 (186.0)	kN (lb)	-	-	-	-	-
		<i>V_{sa}</i>	lb (kN)	5,815 (25.9)	10,645 (47.3)	16,950 (75.4)	25,090 (111.6)	kN (lb)	-	-	-	-	-
	Nominal steel strength – HIS-N insert	<i>N_{sa}</i>	lb (kN)	12,645 (56.3)	17,250 (76.7)	28,680 (127.6)	29,145 (129.7)	kN (lb)	-	-	-	-	-
ASTM A193 Grade B8M SS	Nominal steel strength – ASTM A193 Grade B8M SS bolt/cap screw	<i>N_{sa}</i>	lb (kN)	8,525 (37.9)	15,610 (69.4)	24,860 (110.6)	36,795 (163.7)	kN (lb)	-	-	-	-	-
		<i>V_{sa}</i>	lb (kN)	5,115 (22.8)	9,365 (41.7)	14,915 (66.3)	22,075 (98.2)	kN (lb)	-	-	-	-	-
	Nominal steel strength – HIS-RN insert	<i>N_{sa}</i>	lb (kN)	18,065 (80.4)	24,645 (109.6)	40,970 (182.2)	41,635 (185.2)	kN (lb)	-	-	-	-	-
ISO 898-1 Class 8.8	Nominal steel strength – ISO 898-1 Class 8.8 bolt/cap screw	<i>N_{sa}</i>	lb (kN)	-	-	-	-	kN (lb)	29.5 (6,582)	46.5 (10,431)	67.5 (15,161)	125.5 (28,236)	196.0 (44,063)
		<i>V_{sa}</i>	lb (kN)	-	-	-	-	kN (lb)	17.5 (3,949)	28.0 (6,259)	40.5 (9,097)	75.5 (16,942)	117.5 (26,438)
	Nominal steel strength – HIS-N insert	<i>N_{sa}</i>	lb (kN)	-	-	-	-	kN (lb)	25.0 (5,669)	53.0 (11,894)	83.0 (18,628)	125.5 (28,210)	116.5 (26,176)
ISO 3506-1 Class A4-70 Stainless	Nominal steel strength – ISO 3506-1 Class A4-70 Stainless bolt/cap screw	<i>N_{sa}</i>	lb (kN)	-	-	-	-	kN (lb)	25.5 (5,760)	40.5 (9,127)	59.0 (13,266)	110.0 (24,706)	171.5 (38,555)
		<i>V_{sa}</i>	lb (kN)	-	-	-	-	kN (lb)	15.5 (3,456)	24.5 (5,476)	35.5 (7,960)	66.0 (14,824)	103.0 (23,133)
	Nominal steel strength – HIS-RN insert	<i>N_{sa}</i>	lb (kN)	-	-	-	-	kN (lb)	36.0 (8,099)	75.5 (16,991)	118.5 (26,612)	179.5 (40,300)	166.5 (37,394)
Reduction for seismic shear	<i>α_{V,seis}</i>	-	0.94				-	0.94					
Strength reduction factor for tension ²	<i>φ</i>	-	0.65				-	0.65					
Strength reduction factor for shear ²	<i>φ</i>	-	0.60				-	0.60					

For **SI**: 1 inch ≅ 25.4 mm, 1 lbf = 4.448 N, 1 psi = 0.006897MPa.

For pound-inch units: 1 mm = 0.03937 inches, 1 N = 0.2248 lbf, 1 MPa = 145.0 psi

¹Values provided for common rod material types based on specified strengths and calculated in accordance with ACI 318-19 Eq. (17.6.1.2) and Eq. (17.7.1.2b), ACI 318-14 Eq. (17.4.1.2) or Eq. (17.5.1.2b) or ACI 318-11 Eq. (D-2) and Eq. (D-29), as applicable. Nuts and washers must be appropriate for the rod.

²For use with the load combinations of ACI 318 (-19 or -14) 5.3 or ACI 318-11 9.2, as applicable, as set forth in ACI 318-19 17.5.3, ACI 318-14 17.3.3 or ACI 318-11 D.4.3, as applicable. Values correspond to a brittle steel element for the HIS insert.

³For the calculation of the design steel strength in tension and shear for the bolt or screw, the *φ* factor for ductile steel failure according to ACI 318-19 17.5.3, ACI 318-14 17.3.3 or ACI 318-11 D.4.3, as applicable, can be used

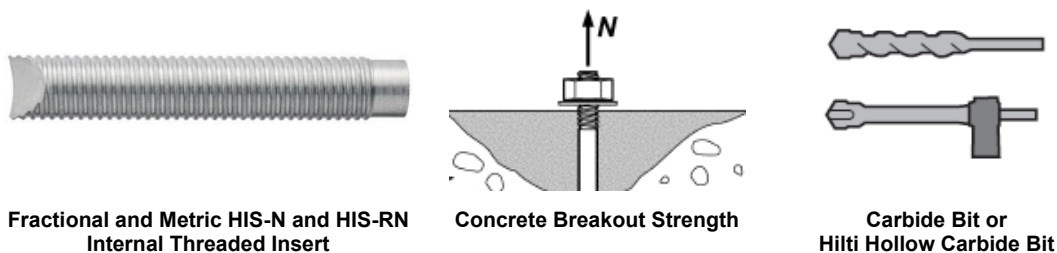

TABLE 27—CONCRETE BREAKOUT DESIGN INFORMATION FOR FRACTIONAL AND METRIC HILTI HIS-N AND HIS-RN INSERTS IN HOLES DRILLED WITH A HAMMER DRILL AND CARBIDE BIT (OR HILTI HOLLOW CARBIDE DRILL BIT)¹

DESIGN INFORMATION	Symbol	Units	Nominal Bolt/Cap Screw Diameter (in.) Fractional				Units	Nominal Bolt/Cap Screw Diameter (mm) Metric				
			³ / ₈	¹ / ₂	⁵ / ₈	³ / ₄		8	10	12	16	20
Effectiveness factor for cracked concrete	$k_{c,cr}$	in-lb (SI)	17 (7.1)				SI (in-lb)	7.1 (17)				
Effectiveness factor for uncracked concrete	$k_{c,uncr}$	in-lb (SI)	24 (10)				SI (in-lb)	10 (24)				
Effective embedment depth	h_{ef}	in. (mm)	4 ³ / ₈ (110)	5 (125)	6 ³ / ₄ (170)	8 ¹ / ₈ (205)	mm (in.)	90 (3.5)	110 (4.3)	125 (4.9)	170 (6.7)	205 (8.1)
Min. anchor spacing ³	s_{min}	in. (mm)	3 ¹ / ₄ (83)	4 (102)	5 (127)	5 ¹ / ₂ (140)	mm (in.)	63 (2.5)	83 (3.25)	102 (4.0)	127 (5.0)	140 (5.5)
Min. edge distance ³	c_{min}	in. (mm)	3 ¹ / ₄ (83)	4 (102)	5 (127)	5 ¹ / ₂ (140)	mm (in.)	63 (2.5)	83 (3.25)	102 (4.0)	127 (5.0)	140 (5.5)
Minimum concrete thickness	h_{min}	in. (mm)	5.9 (150)	6.7 (170)	9.1 (230)	10.6 (270)	mm (in.)	120 (4.7)	150 (5.9)	170 (6.7)	230 (9.1)	270 (10.6)
Critical edge distance – splitting (for uncracked concrete)	c_{ac}	-	See Section 4.1.10 of this report				-	See Section 4.1.10 of this report				
Strength reduction factor for tension, concrete failure modes ²	ϕ	-	0.65				-	0.65				
Strength reduction factor for shear, concrete failure modes ²	ϕ	-	0.70				-	0.70				

For SI: 1 inch ≅ 25.4 mm, 1 lbf = 4.448 N, 1 psi = 0.006897MPa.
 For pound-inch units: 1 mm = 0.03937 inches, 1 N = 0.2248 lbf, 1 MPa = 145.0 psi

¹Additional setting information is described in Figure 8A, Manufacturers Printed Installation Instructions (MPII).
²The strength reduction factor applies when the load combinations from the IBC or ACI 318 are used and the requirements of ACI 318-19 17.5.3, ACI 318-14 17.3.3 or ACI 318-11 D.4.3, as applicable, are met. If the load combinations of ACI 318-11 Appendix C are used, the appropriate strength reduction factor must be determined in accordance with ACI 318-11 D.4.4.
³For installations with 1³/₄-inch edge distance, refer to Section 4.1.9 for spacing and maximum torque requirements.



Fractional and Metric HIS-N and HIS-RN Internal Threaded Insert

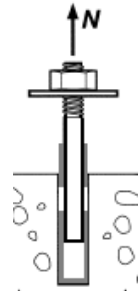

Bond Strength

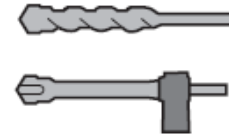

Carbide Bit or Hilti Hollow Carbide Bit

TABLE 28—BOND STRENGTH DESIGN INFORMATION FOR FRACTIONAL AND METRIC HILTI HIS-N AND HIS-RN INSERTS IN HOLES DRILLED WITH A HAMMER DRILL AND CARBIDE BIT (OR HILTI HOLLOW CARBIDE DRILL BIT)¹

DESIGN INFORMATION			Symbol	Units	Nominal bolt/cap screw diameter (in.)				Units	Nominal bolt/cap screw diameter (mm)				
					3/8	1/2	5/8	3/4		8	10	12	16	20
Embedment			h_{ef}	in. (mm)	4 ^{3/8} (110)	5 (125)	6 ^{3/4} (170)	8 ^{1/8} (205)	mm (in.)	90 (3.5)	110 (4.3)	125 (4.9)	170 (6.7)	205 (8.1)
Dry concrete and Water saturated concrete	Temperature range A ²	Characteristic bond strength in cracked concrete	$\tau_{k,cr}$	psi (MPa)	1,070 (7.4)	1,070 (7.4)	1,070 (7.4)	1,070 (7.4)	MPa (psi)	7.4 (1,070)	7.4 (1,070)	7.4 (1,070)	7.4 (1,070)	7.4 (1,070)
		Characteristic bond strength in uncracked concrete	$\tau_{k,uncr}$	psi (MPa)	1,790 (12.3)	1,790 (12.3)	1,790 (12.3)	1,790 (12.3)	MPa (psi)	12.3 (1,790)	12.3 (1,790)	12.3 (1,790)	12.3 (1,790)	12.3 (1,790)
	Temperature range B ²	Characteristic bond strength in cracked concrete	$\tau_{k,cr}$	psi (MPa)	740 (5.1)	740 (5.1)	740 (5.1)	740 (5.1)	MPa (psi)	5.1 (740)	5.1 (740)	5.1 (740)	5.1 (740)	5.1 (740)
		Characteristic bond strength in uncracked concrete	$\tau_{k,uncr}$	psi (MPa)	1,240 (8.5)	1,240 (8.5)	1,240 (8.5)	1,240 (8.5)	MPa (psi)	8.5 (1,240)	8.5 (1,240)	8.5 (1,240)	8.5 (1,240)	8.5 (1,240)
	Anchor Category		-	-	1	1	1	1	-	1	1	1	1	1
	Strength Reduction factor		ϕ_{dt}, ϕ_{ws}	-	0.65	0.65	0.65	0.65	-	0.65	0.65	0.65	0.65	0.65
Water-filled hole	Temperature range A ²	Characteristic bond strength in cracked concrete	$\tau_{k,cr}$	psi (MPa)	800 (5.5)	810 (5.6)	820 (5.7)	820 (5.7)	MPa (psi)	5.5 (790)	5.5 (800)	5.6 (810)	5.7 (820)	5.7 (820)
		Characteristic bond strength in uncracked concrete	$\tau_{k,uncr}$	psi (MPa)	1,340 (9.2)	1,350 (9.3)	1,370 (9.5)	1,380 (9.5)	MPa (psi)	9.1 (1,330)	9.2 (1,340)	9.3 (1,350)	9.5 (1,370)	9.5 (1,380)
	Temperature range B ²	Characteristic bond strength in cracked concrete	$\tau_{k,cr}$	psi (MPa)	550 (3.8)	560 (3.8)	570 (3.9)	570 (3.9)	MPa (psi)	3.8 (550)	3.8 (550)	3.8 (560)	3.9 (570)	3.9 (570)
		Characteristic bond strength in uncracked concrete	$\tau_{k,uncr}$	psi (MPa)	920 (6.4)	930 (6.4)	950 (6.5)	950 (6.6)	MPa (psi)	6.3 (920)	6.4 (920)	6.4 (930)	6.5 (950)	6.6 (950)
	Anchor Category		-	-	3	3	3	3	-	3	3	3	3	3
	Strength Reduction factor		ϕ_{wf}	-	0.45	0.45	0.45	0.45	-	0.45	0.45	0.45	0.45	0.45
Submerged concrete	Temperature range A ²	Characteristic bond strength in cracked concrete	$\tau_{k,cr}$	psi (MPa)	710 (4.9)	720 (5.0)	750 (5.1)	750 (5.2)	MPa (psi)	4.8 (700)	4.9 (710)	5.0 (720)	5.1 (750)	5.2 (750)
		Characteristic bond strength in uncracked concrete	$\tau_{k,uncr}$	psi (MPa)	1,190 (8.2)	1,210 (8.4)	1,250 (8.6)	1,260 (8.7)	MPa (psi)	8.0 (1,160)	8.2 (1,190)	8.4 (1,210)	8.6 (1,250)	8.7 (1,260)
	Temperature range B ²	Characteristic bond strength in cracked concrete	$\tau_{k,cr}$	psi (MPa)	490 (3.4)	500 (3.4)	510 (3.5)	520 (3.6)	MPa (psi)	3.3 (480)	3.4 (490)	3.4 (500)	3.5 (510)	3.6 (520)
		Characteristic bond strength in uncracked concrete	$\tau_{k,uncr}$	psi (MPa)	820 (5.6)	840 (5.8)	860 (5.9)	870 (6.0)	MPa (psi)	5.5 (800)	5.6 (820)	5.8 (840)	5.9 (860)	6.0 (870)
	Anchor Category		-	-	3	3	3	3	-	3	3	3	3	3
	Strength Reduction factor		ϕ_{uw}	-	0.45	0.45	0.45	0.45	-	0.45	0.45	0.45	0.45	0.45
Reduction for seismic tension			$\alpha_{N,seis}$	-	1	1	1	1	-	1	1	1	1	1

For SI: 1 inch ≡ 25.4 mm, 1 lbf = 4.448 N, 1 psi = 0.006897 MPa.

For pound-inch units: 1 mm = 0.03937 inches, 1 N = 0.2248 lbf, 1 MPa = 145.0 psi

¹Bond strength values correspond to concrete compressive strength $f'_c = 2,500$ psi (17.2 MPa). For concrete compressive strength, f'_c , between 2,500 psi (17.2 MPa) and 8,000 psi (55.2 MPa), the tabulated characteristic bond strength may be increased by a factor of $(f'_c / 2,500)^{0.25}$ for uncracked concrete [For SI: $(f'_c / 17.2)^{0.25}$] and $(f'_c / 2,500)^{0.15}$ for cracked concrete [For SI: $(f'_c / 17.2)^{0.15}$]. See Section 4.1.4 of this report for bond strength determination.

²Temperature range A: Maximum short term temperature = 130°F (55°C), Maximum long term temperature = 110°F (43°C).

Temperature range B: Maximum short term temperature = 176°F (80°C), Maximum long term temperature = 110°F (43°C).

Short term elevated concrete temperatures are those that occur over brief intervals, e.g., as a result of diurnal cycling. Long term concrete temperatures are roughly constant over significant periods of time.

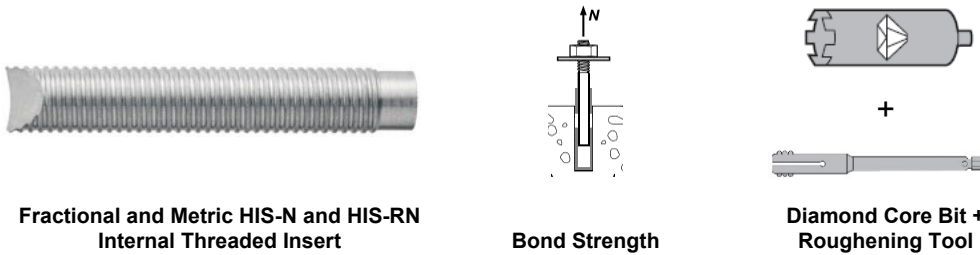

TABLE 29—BOND STRENGTH DESIGN INFORMATION FOR FRACTIONAL AND METRIC HILTI HIS-N AND HIS-RN INSERTS IN HOLES CORE DRILLED WITH A DIAMOND CORE BIT AND ROUGHENED WITH A HILTI ROUGHENING TOOL¹

DESIGN INFORMATION			Symbol	Units	Nominal bolt/cap screw diameter (in.)			Units	Nominal bolt/cap screw diameter (mm)			
					1/2	5/8	3/4		12	16	20	
Embedment			h_{ef}	in. (mm)	5 (125)	6 ³ / ₈ (170)	8 ¹ / ₈ (205)	mm (in.)	125 (4.9)	170 (6.7)	205 (8.1)	
Dry concrete and Water Saturated Concrete	Temperature range A ²	Characteristic bond strength in cracked concrete	$\tau_{k,cr}$	psi (MPa)	750 (5.2)	750 (5.2)	750 (5.2)	MPa (psi)	5.2 (750)	5.2 (750)	5.2 (750)	
		Characteristic bond strength in uncracked concrete	$\tau_{k,uncr}$	psi (MPa)	1,790 (12.3)	1,790 (12.3)	1,790 (12.3)	MPa (psi)	12.3 (1,790)	12.3 (1,790)	12.3 (1,790)	
	Temperature range B ²	Characteristic bond strength in cracked concrete	$\tau_{k,cr}$	psi (MPa)	515 (3.6)	515 (3.6)	515 (3.6)	MPa (psi)	3.6 (515)	3.6 (515)	3.6 (515)	
		Characteristic bond strength in uncracked concrete	$\tau_{k,uncr}$	psi (MPa)	1,240 (8.5)	1,240 (8.5)	1,240 (8.5)	MPa (psi)	8.5 (1,240)	8.5 (1,240)	8.5 (1,240)	
	Anchor Category			-	-	1	1	1	-	1	1	1
	Strength Reduction factor			ϕ_c, ϕ_{vs}	-	0.65	0.65	0.65	-	0.65	0.65	0.65
	Reduction for seismic tension			$\alpha_{N,seis}$	-	1	1	1	-	1	1	1

For SI: 1 inch \equiv 25.4 mm, 1 lbf = 4.448 N, 1 psi = 0.006897 MPa.
 For pound-inch units: 1 mm = 0.03937 inches, 1 N = 0.2248 lbf, 1 MPa = 145.0 psi

¹Bond strength values correspond to concrete compressive strength in the range 2,500 psi \leq $f'_c \leq$ 8,000 psi.
²Temperature range A: Maximum short term temperature = 130°F (55°C), Maximum long term temperature = 110°F (43°C).
 Temperature range B: Maximum short term temperature = 176°F (80°C), Maximum long term temperature = 110°F (43°C).
 Short term elevated concrete temperatures are those that occur over brief intervals, e.g., as a result of diurnal cycling. Long term concrete temperatures are roughly constant over significant periods of time.



Fractional and Metric HIS-N and HIS-RN Internal Threaded Insert

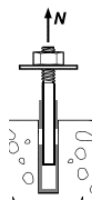

Bond Strength



Diamond Core Bit

TABLE 30—BOND STRENGTH DESIGN INFORMATION FOR FRACTIONAL AND METRIC HILTI HIS-N AND HIS-RN INSERTS IN HOLES CORE DRILLED WITH A DIAMOND CORE BIT¹

DESIGN INFORMATION			Symbol	Units	Nominal bolt/cap screw diameter (in.)				Units	Nominal bolt/cap screw diameter (mm)					
					3/8	1/2	5/8	3/4		8	10	12	16	20	
Embedment			h_{ef}	in. (mm)	4 ³ / ₈ (110)	5 (125)	6 ³ / ₄ (170)	8 ¹ / ₈ (205)	mm (in.)	90 (3.5)	110 (4.3)	125 (4.9)	170 (6.7)	205 (8.1)	
Dry concrete and Water Saturated Concrete	Temperature range A ²	Characteristic bond strength in uncracked concrete	$\tau_{k,uncr}$	psi (MPa)	1,200 (8.3)	1,200 (8.3)	1,200 (8.3)	1,200 (8.3)	MPa (psi)	8.3 (1,200)	8.3 (1,200)	8.3 (1,200)	8.3 (1,200)	8.3 (1,200)	
	Temperature range B ²	Characteristic bond strength in uncracked concrete	$\tau_{k,uncr}$	psi (MPa)	830 (5.7)	830 (5.7)	830 (5.7)	830 (5.7)	MPa (psi)	5.7 (830)	5.7 (830)	5.7 (830)	5.7 (830)	5.7 (830)	
	Anchor Category			-	-	3	3	3	3	-	2	3	3	3	3
	Strength Reduction factor			ϕ_s, ϕ_{ws}	-	0.45	0.45	0.45	0.45	-	0.55	0.45	0.45	0.45	0.45

For SI: 1 inch ≡ 25.4 mm, 1 lbf = 4.448 N, 1 psi = 0.006897 MPa.

For pound-inch units: 1 mm = 0.03937 inches, 1 N = 0.2248 lbf, 1 MPa = 145.0 psi

¹Bond strength values correspond to concrete compressive strength $f'_c = 2,500$ psi (17.2 MPa). For concrete compressive strength, f'_c , between 2,500 psi (17.2 MPa) and 8,000 psi (55.2 MPa), the tabulated characteristic bond strength may be increased by a factor of $(f'_c / 2,500)^{0.25}$ for uncracked concrete [For SI: $(f'_c / 17.2)^{0.25}$]. See Section 4.1.4 of this report for bond strength determination.

²Temperature range A: Maximum short term temperature = 130°F (55°C), Maximum long term temperature = 110°F (43°C).

Temperature range B: Maximum short term temperature = 176°F (80°C), Maximum long term temperature = 110°F (43°C).

Short term elevated concrete temperatures are those that occur over brief intervals, e.g., as a result of diurnal cycling. Long term concrete temperatures are roughly constant over significant periods of time.

TABLE 31—DEVELOPMENT LENGTH FOR U.S. CUSTOMARY UNIT REINFORCING BARS IN HOLES DRILLED WITH A HAMMER DRILL AND CARBIDE BIT OR HILTI HOLLOW CARBIDE BIT OR CORE DRILLED WITH A DIAMOND CORE BIT OR A DIAMOND CORE BIT AND ROUGHENED WITH A HILTI ROUGHENING TOOL^{1,2,5,6}

DESIGN INFORMATION	Symbol	Criteria Section of Reference Standard	Units	Bar Size							
				#3	#4	#5	#6	#7	#8	#9	#10
Nominal reinforcing bar diameter	d_b	ASTM A615/A706	in. (mm)	0.375 (9.5)	0.500 (12.7)	0.625 (15.9)	0.750 (19.1)	0.875 (22.2)	1.000 (25.4)	1.128 (28.7)	1.270 (32.3)
Nominal bar area	A_b	ASTM A615/A706	in ² (mm ²)	0.11 (71)	0.20 (129)	0.31 (199)	0.44 (284)	0.60 (387)	0.79 (510)	1.00 (645)	1.27 (819)
Development length for $f_y = 60$ ksi and $f'_c = 2,500$ psi (normal weight concrete) ^{3,4}	l_d	ACI 318-19 25.4.2.4 ACI 318-14 25.4.2.3 ACI 318-11 12.2.3	in.	12.0	14.4	18.0	21.6	31.5	36.0	40.6	45.7
			(mm)	(304.8)	(365.8)	(457.2)	(548.6)	(800.1)	(914.4)	(1031.4)	(1161.3)
Development length for $f_y = 60$ ksi and $f'_c = 4,000$ psi (normal weight concrete) ^{3,4}	l_d	ACI 318-19 25.4.2.4 ACI 318-14 25.4.2.3 ACI 318-11 12.2.3	in.	12.0	12.0	14.2	17.1	24.9	28.5	32.1	36.1
			(mm)	(304.8)	(304.8)	(361.4)	(433.7)	(632.5)	(722.9)	(815.4)	(918.1)

For SI: 1 inch ≡ 25.4 mm, 1 lbf = 4.448 N, 1 psi = 0.006897 MPa.

For pound-inch units: 1 mm = 0.03937 inches, 1 N = 0.2248 lbf, 1 MPa = 145.0 psi

¹Development lengths valid for static, wind, and earthquake loads (SDC A and B).

²Development lengths in SDC C through F must comply with ACI 318 (-19 or -14) Chapter 18 or ACI 318-11 Chapter 21, as applicable, and section 4.2.4 of this report.

³For all-lightweight concrete, increase development length by 33% unless the provisions of ACI 318-19 25.4.2.5 or ACI 318-14 25.4.2.4 are met to permit $\lambda > 0.75$. For sand-lightweight concrete, increase development length by 18% unless the provisions of ACI 318-19 25.4.2.5 or ACI 318-14 25.4.2.4 are met to permit $\lambda > 0.85$.

⁴ $\left(\frac{c_b + K_{tr}}{d_b}\right) = 2.5, \psi_c = 1.0, \psi_e = 1.0, \psi_s = 0.8$ for $d_b \leq \#6, 1.0$ for $d_b > \#6$

⁵Calculations may be performed for other steel grades per ACI 318 (-19 or -14) Chapter 25 or ACI 318-11 Chapter 12.

⁶Minimum development length shall not be less than 12 in (305 mm) per ACI 318 (-19 or -14) Section 25.4.2.1.

TABLE 32—DEVELOPMENT LENGTH FOR EU METRIC REINFORCING BARS IN HOLES DRILLED WITH A HAMMER DRILL AND CARBIDE BIT OR HILTI HOLLOW CARBIDE BIT OR CORE DRILLED WITH A DIAMOND CORE BIT OR A DIAMOND CORE BIT AND ROUGHENED WITH A HILTI ROUGHENING TOOL^{1,2,5,6}

DESIGN INFORMATION	Symbol	Criteria Section of Reference Standard	Units	Bar Size					
				10	12	16	20	25	32
Nominal reinforcing bar diameter	d_b	BS4449: 2005	mm (in.)	10 (0.394)	12 (0.472)	16 (0.630)	20 (0.787)	25 (0.984)	32 (1.260)
Nominal bar area	A_b	BS 4449: 2005	mm ² (in ²)	78.5 (0.12)	113.1 (0.18)	201.1 (0.31)	314.2 (0.49)	490.9 (0.76)	804.2 (1.25)
Development length for $f_y = 72.5$ ksi and $f_c = 2,500$ psi (normal weight concrete) ^{3,4}	l_d	ACI 318-19 25.4.2.4 ⁷ ACI 318-14 25.4.2.3 ACI 318-11 12.2.3	mm (in.)	348 (13.7)	417 (16.4)	556 (21.9)	871 (34.3)	1087 (42.8)	1392 (54.8)
Development length for $f_y = 72.5$ ksi and $f_c = 4,000$ psi (normal weight concrete) ^{3,4}	l_d	ACI 318-19 25.4.2.4 ⁷ ACI 318-14 25.4.2.3 ACI 318-11 12.2.3	mm (in.)	305 (12.0)	330 (13.0)	439 (17.3)	688 (27.1)	859 (33.8)	1100 (43.3)

For **SI**: 1 inch \equiv 25.4 mm, 1 lbf = 4.448 N, 1 psi = 0.006897 MPa.
For pound-inch units: 1 mm = 0.03937 inches, 1 N = 0.2248 lbf, 1 MPa = 145.0 psi

¹Development lengths valid for static, wind, and earthquake loads (SDC A and B).
²Development lengths in SDC C through F must comply with ACI 318 (-19 or -14) Chapter 18 or ACI 318-11 Chapter 21 and section 4.2.4 of this report.
³ For all-lightweight concrete, increase development length by 33% unless the provisions of ACI 318-19 25.4.2.5 or ACI 318-14 25.4.2.4 are met to permit $\lambda > 0.75$. For sand-lightweight concrete, increase development length by 18% unless the provisions of ACI 318-19 25.4.2.5 or ACI 318-14 25.4.2.4 are met to permit $\lambda > 0.85$.
⁴ $(\frac{c_b + K_{tr}}{d_b}) = 2.5$, $\psi_t = 1.0$, $\psi_e = 1.0$, $\psi_s = 0.8$ for $d_b < 20$ mm, 1.0 for $d_b \geq 20$ mm
⁵Calculations may be performed for other steel grades per ACI 318 (-19 or -14) Chapter 25 or ACI 318-11 Chapter 12.
⁶Minimum development length shall not be less than 12 in (305 mm) per ACI 318 (-19 or -14) Section 25.4.2.1.
⁷ l_d must be increased by 9.5% to account for ψ_g in ACI 318-19 25.4.2.4. ψ_g has been interpolated from Table 25.4.2.5 of ACI 318-19 for $f_y = 72.5$ ksi.

TABLE 33—DEVELOPMENT LENGTH FOR CANADIAN REINFORCING BARS IN HOLES DRILLED WITH A HAMMER DRILL AND CARBIDE BIT OR HILTI HOLLOW CARBIDE BIT OR CORE DRILLED WITH A DIAMOND CORE BIT OR A DIAMOND CORE BIT AND ROUGHENED WITH A HILTI ROUGHENING TOOL^{1,2,5,6}

DESIGN INFORMATION	Symbol	Criteria Section of Reference Standard	Units	Bar Size				
				10M	15M	20M	25M	30M
Nominal reinforcing bar diameter	d_b	CAN/CSA-G30.18 Gr.400	mm (in.)	11.3 (0.445)	16.0 (0.630)	19.5 (0.768)	25.2 (0.992)	29.9 (1.177)
Nominal bar area	A_b	CAN/CSA-G30.18 Gr.400	mm ² (in ²)	100.3 (0.16)	201.1 (0.31)	298.6 (0.46)	498.8 (0.77)	702.2 (1.09)
Development length for $f_y = 58$ ksi and $f_c = 2,500$ psi (normal weight concrete) ^{3,4}	l_d	ACI 318-19 25.4.2.4 ACI 318-14 25.4.2.3 ACI 318-11 12.2.3	mm (in.)	315 (12.4)	445 (17.5)	678 (26.7)	876 (34.5)	1,041 (41.0)
Development length for $f_y = 58$ ksi and $f_c = 4,000$ psi (normal weight concrete) ^{3,4}	l_d	ACI 318-19 25.4.2.4 ACI 318-14 25.4.2.3 ACI 318-11 12.2.3	mm (in.)	305 (12.0)	353 (13.9)	536 (21.1)	693 (27.3)	823 (32.4)

For **SI**: 1 inch \equiv 25.4 mm, 1 lbf = 4.448 N, 1 psi = 0.006897 MPa.
For pound-inch units: 1 mm = 0.03937 inches, 1 N = 0.2248 lbf, 1 MPa = 145.0 psi

¹Development lengths valid for static, wind, and earthquake loads (SDC A and B).
²Development lengths in SDC C through F must comply with ACI 318 (-19 or -14) Chapter 18 or ACI 318-11 Chapter 21 and section 4.2.4 of this report.
³ For all-lightweight concrete, increase development length by 33% unless the provisions of ACI 318-19 25.4.2.5 or ACI 318-14 25.4.2.4 are met to permit $\lambda > 0.75$. For sand-lightweight concrete, increase development length by 18% unless the provisions of ACI 318-19 25.4.2.5 or ACI 318-14 25.4.2.4 are met to permit $\lambda > 0.85$.
⁴ $(\frac{c_b + K_{tr}}{d_b}) = 2.5$, $\psi_t = 1.0$, $\psi_e = 1.0$, $\psi_s = 0.8$ for $d_b < 20$ M, 1.0 for $d_b \geq 20$ M
⁵Calculations may be performed for other steel grades per ACI 318 (-19 or -14) Chapter 25 or ACI 318-11 Chapter 12.
⁶Minimum development length shall not be less than 12 in (305 mm) per ACI 318 (-19 or -14) Section 25.4.2.1.

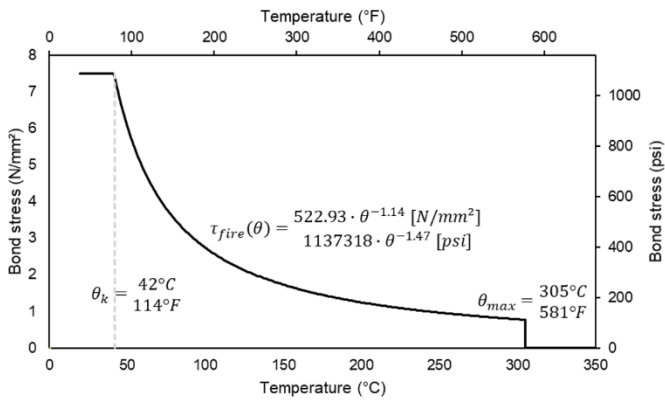

FIGURE 6A

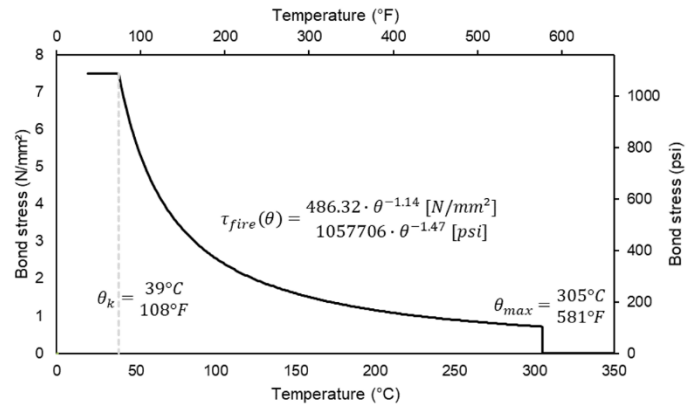

FIGURE 6B

FIGURE 6 – BOND STRESS VS TEMPERATURE OF POST INSTALLED REINFORCING BAR APPLICATIONS SUBJECT TO ELEVATED TEMPERATURE / FIRE. FIGURE 6A FOR SHORT TERM LOADS INCLUDING SEISMIC; FIGURE 6B FOR SUSTAINED LOADS INCLUDING SEISMIC



HILTI HIT-RE 500 V3 FOIL PACK AND MIXING NOZZLE



HILTI DISPENSER

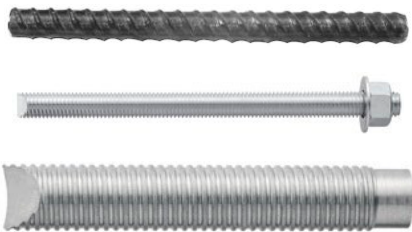

ANCHORING ELEMENTS



HILTI TE-CD OR TE-YD HOLLOW CARBIDE DRILL BIT



HILTI TE-YRT ROUGHENING TOOL

FIGURE 7—HILTI HIT-RE 500 V3 ANCHORING SYSTEM

HILTI

Hilti HIT-RE 500 V3

Instructions for use en
 Instrucciones de uso es
 Mode d'emploi fr
 Instruções de utilização pt

Danger

Contains epoxy constituents. May produce an allergic reaction (A)

Contains reaction product: bisphenol-A/F-(epichlorohydrin) epoxy resin MW ≤ 700 (A), butanedioldiglycidyl ether (A), m-Xylenediamine (B), 2-methyl-1,5-pentanediamine (B)

Causes severe skin burns and eye damage (B)
 May cause respiratory irritation (B)
 May cause an allergic skin reaction (A,B)
 Toxic to aquatic life with long lasting effects (A)

ICC-ES ESR - 3814

1			$\frac{7}{16}'' \dots 1 \frac{3}{4}''$ 10...40 mm	$2 \frac{3}{8}'' \dots 10''$ 60...250 mm			16 17
2			$\frac{7}{16}'' \dots 1 \frac{3}{4}''$ 10...40 mm	$2 \frac{3}{8}'' \dots 75''$ 60...1920 mm			18 19
3			$\frac{7}{16}'' \dots 1 \frac{3}{4}''$ 10...40 mm	$2 \frac{3}{8}'' \dots 10''$ 60...250 mm			20 21
4			$\frac{7}{16}'' \dots 1 \frac{3}{4}''$ 10...40 mm	$2 \frac{3}{8}'' \dots 10''$ 60...250 mm			22 23
5			$\frac{7}{16}'' \dots 1 \frac{3}{4}''$ 10...40 mm	$2 \frac{3}{8}'' \dots 75''$ 60...1920 mm			24 25
6			$\frac{7}{16}'' \dots 1 \frac{3}{4}''$ 10...40 mm	$2 \frac{3}{8}'' \dots 25''$ 60...640 mm			26 27
7			$\frac{9}{16}'' \dots 1 \frac{1}{8}''$ 14...32 mm	$2 \frac{3}{8}'' \dots 10''$ 60...250 mm			28 29

8			$\frac{9}{16}'' \dots 1 \frac{1}{8}''$ 14...32 mm	$2 \frac{3}{8}'' \dots 39 \frac{3}{8}''$ 60...1000 mm			30 31
9			$\frac{9}{16}'' \dots 1 \frac{1}{8}''$ 14...32 mm	$2 \frac{3}{8}'' \dots 39 \frac{3}{8}''$ 60...1000 mm			32 33
10			$\frac{3}{4}'' \dots 1 \frac{3}{8}''$ 18...35 mm	$3 \frac{1}{8}'' \dots 10''$ 80...250 mm			34 35
11			$\frac{3}{4}'' \dots 1 \frac{3}{8}''$ 18...35 mm	$3 \frac{1}{8}'' \dots 25''$ 80...635 mm			36 37
12			$\frac{3}{4}'' \dots 1 \frac{3}{8}''$ 18...35 mm	$3 \frac{1}{8}'' \dots 25''$ 80...635 mm			38 39
13			$\frac{7}{16}'' \dots 1 \frac{3}{4}''$ 10...40 mm	$2 \frac{3}{8}'' \dots 10''$ 60...250 mm			22 23
14			$\frac{7}{16}'' \dots 1 \frac{3}{4}''$ 10...40 mm	$2 \frac{3}{8}'' \dots 25''$ 60...640 mm			24 25
15			$\frac{7}{16}'' \dots 1 \frac{3}{4}''$ 10...40 mm	$2 \frac{3}{8}'' \dots 25''$ 60...640 mm			40 41

en Dry concrete Water saturated concrete Waterfilled borehole in concrete Submerged borehole in concrete

en Threaded rod Threaded sleeve Rebar Uncracked concrete Cracked concrete

en Hammer drilling Diamond coring Hollow drill bit Roughening tool

en Working time Initial curing time Curing time Roughening time

HIT-V (-R, -F, -HCR) / HAS-E (-B7) / HAS-R

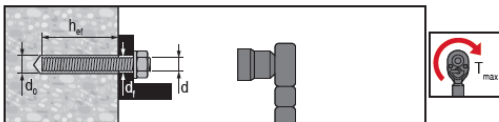

HAS / HIT-V

Ø d [inch]	Ø d ₀ [inch]	h _{cr} [inch]	Ø d ₁ [inch]	T _{max} [ft-lb]	T _{max} [Nm]
3/8	7/16	2 3/8 ... 7 1/2	7/16	15	20
1/2	9/16	2 3/4 ... 10	9/16	30	41
5/8	3/4	3 1/8 ... 12 1/2	11/16	60	81
3/4	7/8	3 1/2 ... 15	13/16	100	136
7/8	1	3 1/2 ... 17 1/2	15/16	125	169
1	1 1/8	4 ... 20	1 1/8	150	203
1 1/4	1 3/8	5 ... 25	1 3/8	200	271

HIT-V

Ø d [mm]	Ø d ₀ [mm]	h _{cr} [mm]	Ø d ₁ [mm]	T _{max} [Nm]
M8	10	60...160	9	10
M10	12	60...200	12	20
M12	14	70...240	14	40
M16	18	80...320	18	80
M20	22	90...400	22	150
M24	28	100...480	26	200
M27	30	110...540	30	270
M30	35	120...600	33	300

1 inch = 25,4 mm

HIS (-H, -RM)

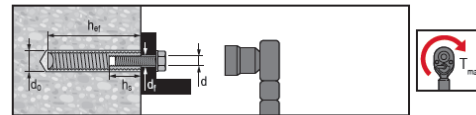

Ø d [inch]	Ø d ₀ [inch]	h _{cr} [inch]	Ø d ₁ [inch]	h _s [inch]	T _{max} [ft-lb]	T _{max} [Nm]
3/8	11/16	4 3/8	7/16	3/8...15/16	15	20
1/2	7/8	5	9/16	1/2...1 3/16	30	41
5/8	1 1/8	6 3/4	11/16	5/8...1 1/2	60	81
3/4	1 1/4	8 1/8	13/16	3/4...1 7/8	100	136

Ø d [mm]	Ø d ₀ [mm]	h _{cr} [mm]	Ø d ₁ [mm]	h _s [mm]	T _{max} [Nm]
M8	14	90	9	8...20	10
M10	18	110	12	10...25	20
M12	22	125	14	12...30	40
M16	28	170	18	16...40	80
M20	32	205	22	20...50	150

FIGURE 8A—MANUFACTURER'S PRINTED INSTALLATION INSTRUCTIONS (MPII)

Rebar

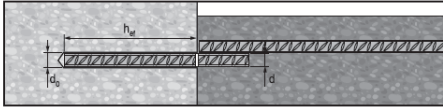

US Rebar

d	Ø d _b [inch]	h _{ef} [inch]
#3	1/2	2 3/8...22 1/2
#4	5/8	2 3/4...30
#5	3/4	3 1/8...37 1/2
#6	7/8	3 1/2...45
#7	1	3 1/2...47 1/2
#8	1 1/8	4...20
#9	1 1/4	4...20
#10	1 1/2	4 1/2...67 1/2
#11	1 3/4	5...75

CA Rebar

d	Ø d _b [inch]	h _{ef} [mm]
10 M	3/16	70...678
15 M	3/4	80...960
20 M	1	90...1170
25 M	1 1/4 (32 mm)	101...1512
30 M	1 1/2	120...1794

1 inch = 25.4 mm

Ø	HAS	HIS-N	Rebar	HIT-RB	HIT-SZ	HIT-DL	TE-YRT
d _b [inch]	d [inch]	[inch]	[inch]	[inch]	[inch]	[inch]	[inch]
3/16	3/16	-	-	3/16	-	-	-
1/2	-	-	#3	1/2	1/2	1/2	-
5/8	-	-	10M	5/8	5/8	5/8	-
3/4	-	-	#4	3/4	3/4	3/4	-
7/8	-	3/4	-	7/8	7/8	7/8	-
1	-	15M #5	-	1	1	1	1
1 1/8	1	20M #6 #7	-	1 1/8	1 1/8	1	1 1/8
1 1/4	-	#7 #8	1 1/4	1 1/4	1 1/4	1	1 1/4
1 1/2	-	25M #8	1 1/2	1 1/2	1 1/2	1	1 1/2
1 3/4	1 1/4	-	#9	1 3/4	1 3/4	1 3/4	1 3/4
1 3/8	-	-	30M #10	1 3/8	1 3/8	1 3/8	1 3/8
1 3/4	-	-	#11	1 3/4	1 3/4	1 3/4	1 3/4

HIT-DL: h_{ef} > 10" HIT-RB: h_{ef} > 20 x d

HIT-RE-M	HIT-OHW
Art. No.	Art. No.
Hill VC 337111	HDM 330 / 500 HDE 500-A18 387550

Ø	h _{ef}	Art. No. 381215	Pressure
d _b [inch]	[inch]		≥ 6 bar/90 psi @ 6 m/h
1/4" - 1 1/4"	2 1/4" - 52 1/2"	✓	≥ 140 m/h / 2.82 CFM
1 1/4" - 1 1/4"	4" - 75"	-	

T	[°F]	[°C]	t _{work}	t _{open, HI}	t _{open, full}
23	-5	2 h	48 h	168 h	
32	0	2 h	24 h	36 h	
40	4	2 h	16 h	24 h	
50	10	1.5 h	12 h	16 h	
60	16	1 h	8 h	16 h	
72	22	25 min	4 h	6.5 h	
85	29	15 min	2.5 h	5 h	
95	35	12 min	2 h	4.5 h	
105	41	10 min	2 h	4 h	

≥ +5 °C / 41 °F = 2x t_{open}

h _{ef} [inch]	h _{ef} [mm]	t _{roughen}
0 ... 4	0 ... 100	10 sec
4.01 ... 8	101 ... 200	20 sec
8.01 ... 12	201 ... 300	30 sec
12.01 ... 16	301 ... 400	40 sec
16.01 ... 20	401 ... 500	50 sec

t_{roughen} = h_{ef} [inch] * 2.5 t_{roughen} = h_{ef} [mm] / 10

Rebar

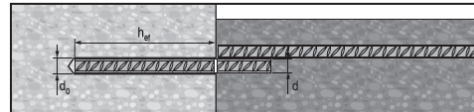

EU Rebar

Ø d [mm]	Ø d _b [mm]	h _{ef} [mm]
8	12	60...480
10	14	60...600
12	16	70...720
14	18	75...840
16	20	80...960
18	22	85...1080
20	25	90...1200
22	28	95...1320
24	32	96...1440
25	32	100...1500
26	35	104...1560
28	35	112...1680
30	37	120...1800
32	40	128...1920

Ø	HIT-V	HIS-N	Rebar	HIT-RB	HIT-SZ	HIT-DL	TE-YRT
d _b [mm]	d [mm]	[mm]	[mm]	[mm]	[mm]	[mm]	[mm]
10	8	-	-	10	-	-	-
12	10	-	8	12	12	12	-
14	12	8	10	14	14	14	-
16	-	-	12	16	16	16	-
18	16	10	14	18	18	18	18
20	-	-	16	20	20	20	20
22	20	12	18	22	22	20	22
25	-	-	20	25	25	25	25
28	24	16	22	28	28	25	28
30	27	-	-	30	30	25	30
32	-	20	24/25	32	32	32	32
35	30	-	26/28	35	35	32	35
37	-	-	30	37	37	32	37
40	-	-	32	40	40	32	40

HIT-DL: h_{ef} > 250 mm HIT-RB: h_{ef} > 20 x d

HIT-RE-M	HIT-OHW
Art. No.	Art. No.
Hill VC 337111	HDM 330 / 500 HDE 500-A18 387550

Ø	h _{ef}	Art. No. 381215	Pressure
d _b [mm]	[mm]		≥ 6 bar/90 psi
10...32	60...1500	✓	≥ 140 m/h
35...40	100...1920	-	

Rebar - h_{ef} ≥ 20d

Rebar	h _{ef}	Temperature	t _{open}
HDM, HDE, HIT-P 80000	≤ US #5	12 1/2 ... 37 1/2 [inch]	23 °F ... 104 °F / 5 °C ... 40 °C
	≤ EU 16mm	320 ... 960 [mm]	
	≤ CAN 15M	320 ... 960 [mm]	
HDE, HIT-P 80000	≤ US #7	17 1/2 ... 52 1/2 [inch]	23 °F ... 104 °F / 5 °C ... 40 °C
	≤ EU 20mm	400 ... 1200 [mm]	
	≤ CAN 20M	390 ... 1170 [mm]	
HIT-P 80000	≤ US #10	25 ... 75 [inch]	23 °F ... 104 °F / 5 °C ... 40 °C
	≤ EU 32mm	640 ... 1920 [mm]	
	≤ CAN 30M	598 ... 1794 [mm]	

Rebar	h _{ef}	Temperature	t _{open}
HDM, HDE, HIT-P 80000	≤ US #5	12 1/2 ... 37 1/2 [inch]	23 °F ... 104 °F / 5 °C ... 40 °C
	≤ EU 16mm	320 ... 960 [mm]	
	≤ CAN 15M	320 ... 960 [mm]	
HDE, HIT-P 80000	≤ US #7	17 1/2 ... 39 3/8 [inch]	23 °F ... 104 °F / 5 °C ... 40 °C
	≤ EU 20mm	400 ... 1000 [mm]	
	≤ CAN 20M	390 ... 1000 [mm]	

FIGURE 8A—MANUFACTURER'S PRINTED INSTALLATION INSTRUCTIONS (MPII) (Continued)

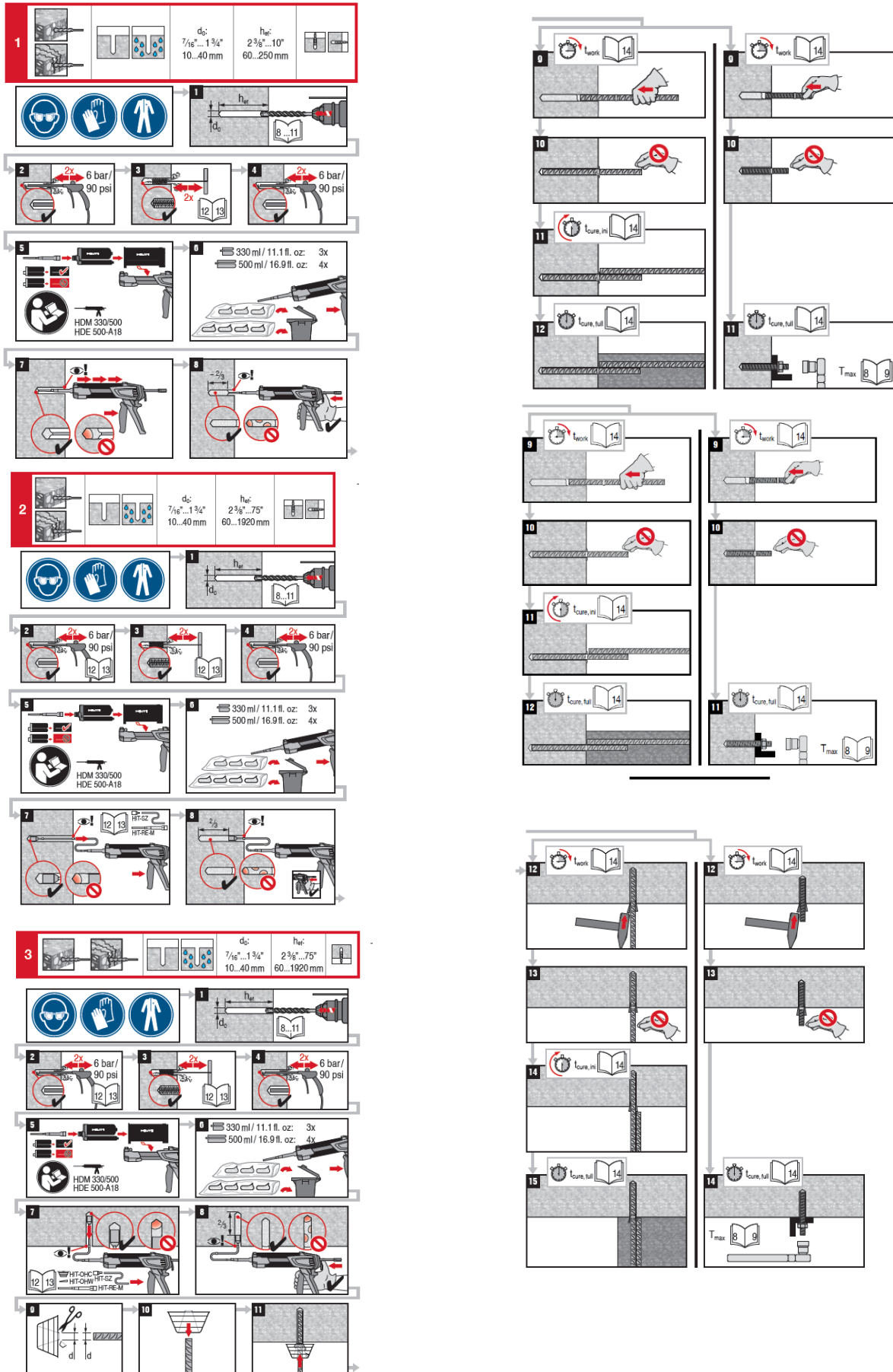



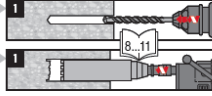

FIGURE 8A—MANUFACTURER’S PRINTED INSTALLATION INSTRUCTIONS (MPII) (Continued)



4  

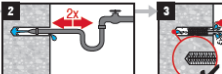
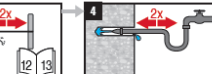
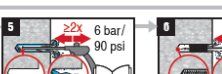

d_c :	d_{ref} :
7/16" ... 1 1/4"	2 3/8" ... 10"
10...40 mm	60...250 mm

13 

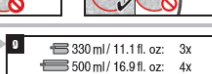
1 

2  **3**  **4** 

5  **6**  **7** 

8  **9** 

HDM 330/500
HDE 500-A18

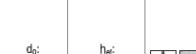

330 ml / 11.1 fl. oz.: 3x
500 ml / 16.9 fl. oz.: 4x

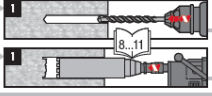

5  

d_c :	d_{ref} :
7/16" ... 1 1/4"	2 3/8" ... 7 5/8"
10...40 mm	60...1920 mm

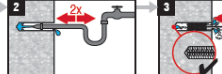
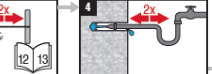
14 

1 

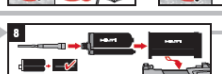
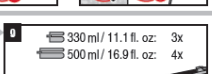
2  **3**  **4** 

5  **6**  **7** 

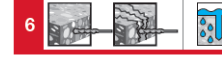
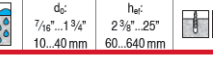
8  **9** 

HDM 330/500
HDE 500-A18

330 ml / 11.1 fl. oz.: 3x
500 ml / 16.9 fl. oz.: 4x

6  

d_c :	d_{ref} :
7/16" ... 1 1/4"	2 3/8" ... 25"
10...40 mm	60...640 mm

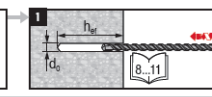

1 

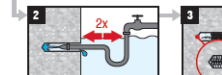
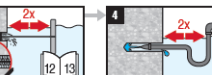
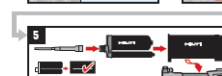
2  **3**  **4** 

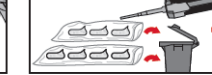
5  **6** 

HDM 330/500

330 ml / 11.1 fl. oz.: 3x
500 ml / 16.9 fl. oz.: 4x

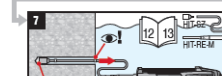
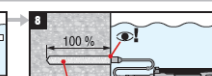
7  **8** 

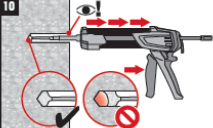
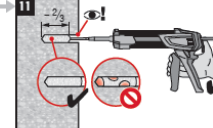
10  **11** 

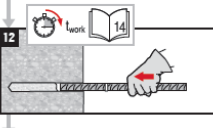
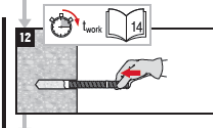
12  **13** 

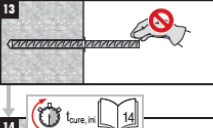
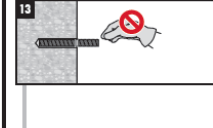
14  **15** 

$t_{cure, in}$ **14**

$t_{cure, full}$ **14**

T_{max} **8 9**

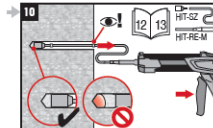
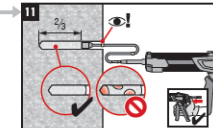
10  **11** 

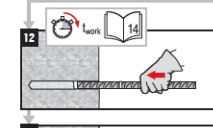
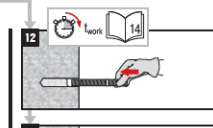

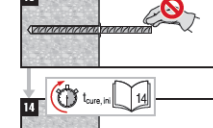
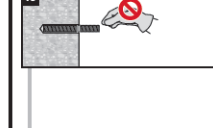
12  **13** 

14  **15** 

$t_{cure, in}$ **14**

$t_{cure, full}$ **14**

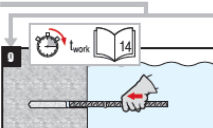
T_{max} **8 9**

0  **1** 

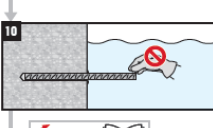
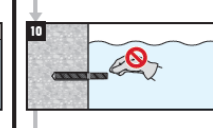
10  **11** 

$t_{cure, in}$ **14**

$t_{cure, full}$ **14**

T_{max} **8 9**

FIGURE 8A—MANUFACTURER'S PRINTED INSTALLATION INSTRUCTIONS (MPII) (Continued)

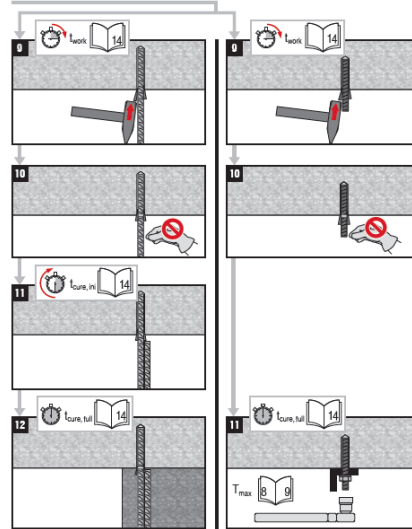
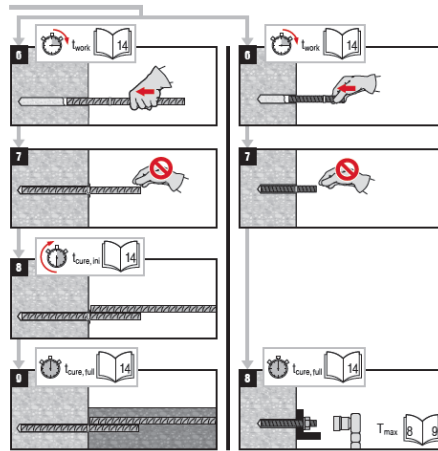
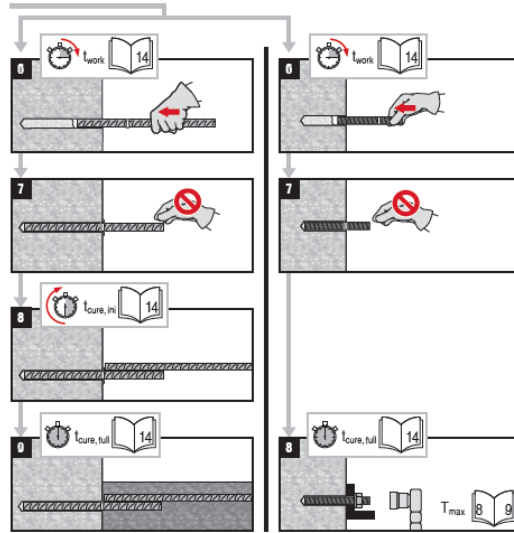
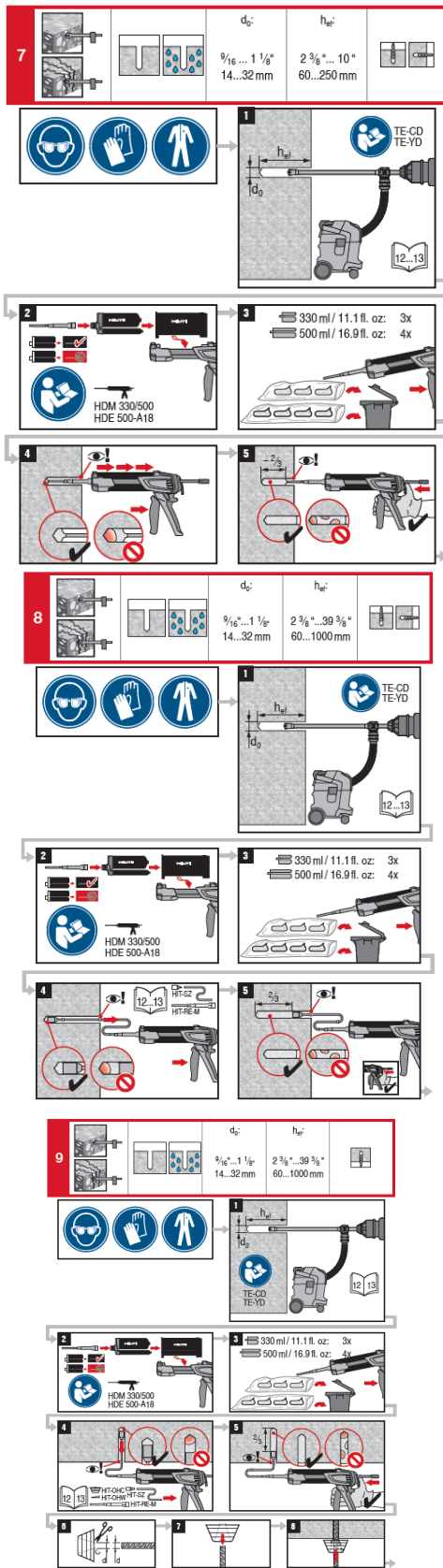

FIGURE 8A—MANUFACTURER'S PRINTED INSTALLATION INSTRUCTIONS (MPII) (Continued)

10			$\frac{3}{4}'' \dots 1 \frac{3}{8}''$ 18...35 mm	$3 \frac{1}{8}'' \dots 10''$ 80...250 mm	

1		2			
3		4			
5		6			
11			$\frac{3}{4}'' \dots 1 \frac{3}{8}''$ 18...35 mm	$3 \frac{1}{8}'' \dots 25''$ 80...635 mm	

1		2			
3		4			
5		6			
12			$\frac{3}{4}'' \dots 1 \frac{3}{8}''$ 18...35 mm	$3 \frac{1}{8}'' \dots 25''$ 80...635 mm	

1		2	
3		4	
5		6	
7		8	

7		8	
9		10	
11		12	
7		8	
9		10	
11		12	
9		10	
11		12	
9		10	
11		12	
9		10	
11		12	

FIGURE 8A—MANUFACTURER’S PRINTED INSTALLATION INSTRUCTIONS (MPII) (Continued)

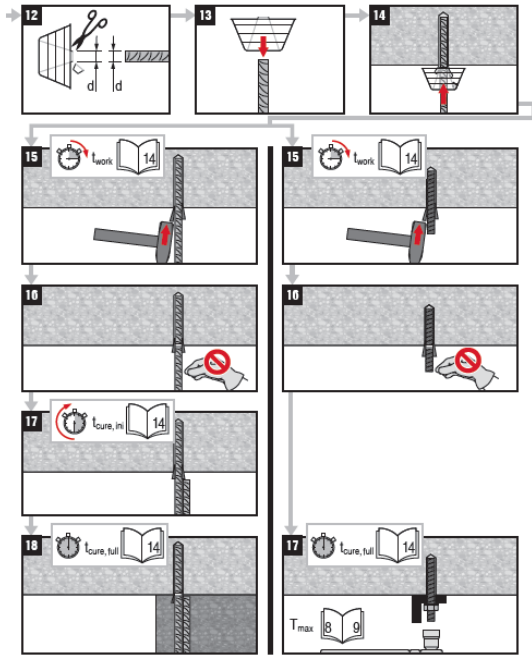
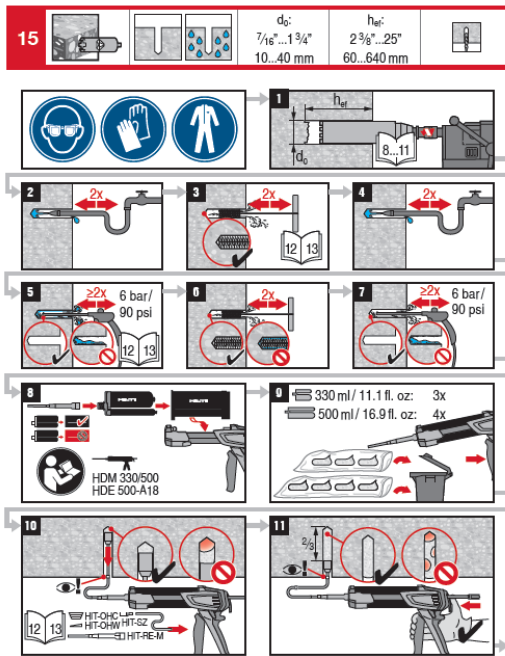

Adhesive anchoring system for rebar and anchor fastenings in concrete

- Prior to use of product, follow the instructions for use and the legally obligated safety precautions.
- See the Safety Data Sheet for this product.

Hilti HIT-RE 500 V3
 Contains epoxy constituents. May produce an allergic reaction (A)
 Contains: reaction product: bisphenol-A/F-(epichlorohydrin) epoxy resin MW ≤ 700 (A), butanedioldiglycidyl ether (A), m-Xylenediamine (B), 2-methyl-1,5-pentanediamine (B)

Danger (A, B) (A, B) (A)

H314 Causes severe skin burns and eye damage (A, B)
 H317 May cause an allergic skin reaction (A, B)
 H335 May cause respiratory irritation (B)
 H411 Toxic to aquatic life with long lasting effects (A)

P280 Wear protective gloves/protective clothing/eye protection/face protection.
 P260 Do not breathe vapours.
 P303+P361+P353 IF ON SKIN (or hair): Remove/Take off immediately all contaminated clothing. Rinse skin with water/shower.
 P305+P351+P338 IF IN EYES: Rinse cautiously with water for several minutes. Remove contact lenses, if present and easy to do. Continue rinsing.
 P333+P313 If skin irritation or rash occurs: Get medical advice/attention.
 P337+P313 If eye irritation persists: Get medical advice/attention.

Recommended protective equipment:
 Eye protection: Tightly sealed safety glasses e.g.: #02065449 Safety glasses PP EY-CA NCH clear; #02065591 Goggles FP EY-HA R HC/AR clear.
 Protective gloves: EN 374 ; Material of gloves: Nitrile rubber, NBR
 Avoid direct contact with the chemical/ the product/ the preparation by organizational measures.
 Final selection of appropriate protective equipment is the responsibility of the user

Disposal considerations

- Empty packs:**
- Leave the Mixer attached and dispose of via the local Green Dot collecting system
 - or EAK waste material code 15 01 02 plastic packaging.
- Full or partially emptied packs:**
- dispose of as special waste in accordance with official regulations.
 - EAK waste material code: 20 01 27 paint, inks, adhesives and resins containing dangerous substances.
 - or waste material code: EAK 08 04 09 waste adhesives and sealants containing organic solvents or other dangerous substances.
- Content: 330 ml / 11.1 fl. oz. 500 ml / 16.9 fl. oz.
 Weight: 465 g / 16.4 oz. 705 g / 24.9 oz.

Warranty: Refer to standard Hilti terms and conditions of sale for warranty information.

Failure to observe these installation instructions, use of non-Hilti anchors, poor or questionable concrete conditions, or unique applications may affect the reliability or performance of the fastenings.

Product Information

- Always keep this instruction for use together with the product.
- Ensure that the instruction for use is with the product when it is given to other persons.
- Safety Data Sheet: Review the DS before use.
- Check expiration date: See expiration date imprint on foil pack manifold (month/year). Do not use expired product.
- **Foil pack temperature during usage:** +5 °C to 40 °C / 41 °F to 104 °F
- **Conditions for transport and storage:** Keep in a cool, dry and dark place between +5 °C to 25 °C / 41 °F to 77 °F
- For any application not covered by this document / beyond values specified, please contact Hilti.
- **Partly used foil packs must be used up within 4 weeks.** Leave the mixer attached on the foil pack manifold and store under the recommended storage conditions. If reused, attach a new mixer and discard the initial quantity of anchor adhesive.

WARNING

- ▲ **Improper handling may cause mortar splashes. Eye contact with mortar may cause irreversible eye damage**
 - Always wear tightly sealed safety glasses, gloves and protective clothes before handling the mortar!
 - Never start dispensing without a mixer properly screwed on.
 - When using an extension hose: Discard of initial mortar flow must be done through supplied mixer only (not through the extension hose).
 - Attach a new mixer prior to dispensing a new foil pack (plug fit).
 - Caution! Never remove the mixer while the foil pack system is under pressure. Press the release button of the dispenser to avoid mortar splashing.
 - Use only the type of mixer supplied with the adhesive. Do not modify the mixer in any way.
 - Never use damaged foil packs and/or damaged or unclear foil pack holders.
- ▲ **Poor load values / potential failures at fastening points due to inadequate borehole cleaning. The boreholes must be dry and free of debris, dust, water, ice, oil, grease and other contaminants prior to adhesive injection.**
 - For blowing out the borehole - blow out with oil free air until return air stream is free of noticeable dust.
 - For flushing the borehole - flush with water line pressure until water runs clear.
 - Important! Remove all water from the borehole and blow out with oil free compressed air until borehole is completely dried before mortar injection (not applicable to hammer drilled hole in underwater application).
- ▲ **Ensure that boreholes are filled from the back of the boreholes without forming air voids.**
 - If necessary, use the accessories / extensions to reach the back of the borehole.
 - For overhead applications use the overhead accessories HIT-GZ / IP and take special care when inserting the fastening element. Excess adhesive may be forced out of the borehole. Make sure that no mortar drips onto the installer.
 - If a new mixer is installed onto a previously-opened foil pack, the first trigger pulls must be discarded.
 - A new mixer must be used for each new foil pack.

FIGURE 8A—MANUFACTURER’S PRINTED INSTALLATION INSTRUCTIONS (MPII) (Continued)

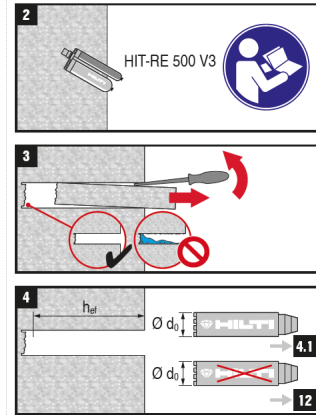
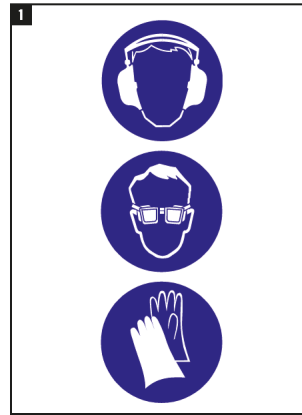
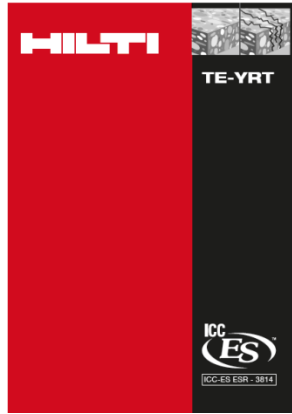

4.1	Ø d ₀ [mm]	TE-YRT
	18	TE-YRT 18/320
	20	TE-YRT 20/320
	22	TE-YRT 22/400
	25	TE-YRT 25/400
	28	TE-YRT 28/480
	30	TE-YRT 30/540
	32	TE-YRT 32/500
	35	TE-YRT 35/600
	Ø d ₀ [inch]	TE-YRT
	3/4"	TE-YRT 3/4" / 12 1/2"
	7/8"	TE-YRT 7/8" / 15"
	1"	TE-YRT 1" / 17 1/2"
	1 1/8"	TE-YRT 1 1/8" / 20"
	1 3/8"	TE-YRT 1 3/8" / 25"

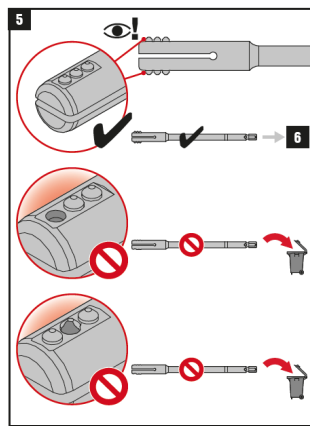

TE-YRT	RTG
TE-YRT 18/320	RTG 18
TE-YRT 20/320	RTG 20
TE-YRT 22/400	RTG 22
TE-YRT 25/400	RTG 25
TE-YRT 28/480	RTG 28
TE-YRT 30/540	RTG 30
TE-YRT 32/500	RTG 32
TE-YRT 35/600	RTG 35
TE-YRT	RTG
TE-YRT 3/4" / 12 1/2"	RTG 3/4"
TE-YRT 7/8" / 15"	RTG 7/8"
TE-YRT 1" / 17 1/2"	RTG 1"
TE-YRT 1 1/8" / 20"	RTG 1 1/8"
TE-YRT 1 3/8" / 25"	RTG 1 3/8"

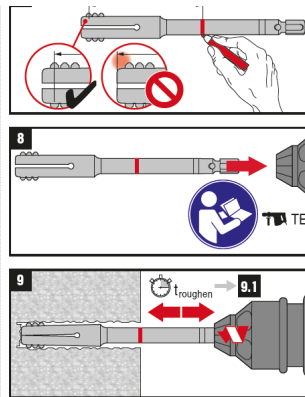
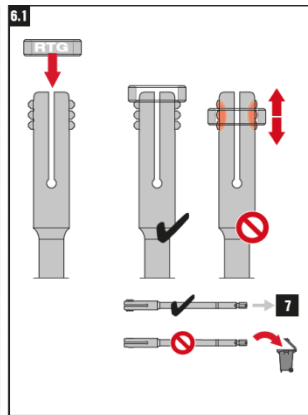

9.1	h _{ref} [mm]	t _{toughen} (= h _{ref} / 10)
	0 ... 100	10 sec
	101 ... 200	20 sec
	201 ... 300	30 sec
	301 ... 400	40 sec
	401 ... 500	50 sec
	501 ... 600	60 sec
	h _{ref} [inch]	t _{toughen} (= h _{ref} · 2.5)
	0 ... 4	10 sec
	4.01 ... 8	20 sec
	8.01 ... 12	30 sec
	12.01 ... 16	40 sec
	16.01 ... 20	50 sec
	20.01 ... 25	60 sec

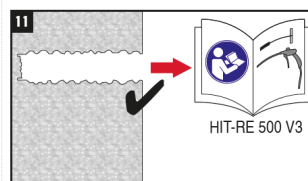
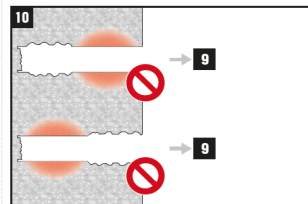
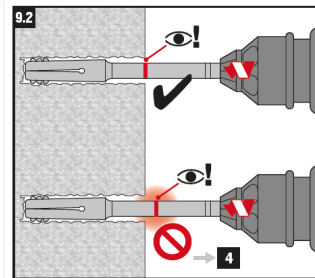

12	Ø d ₀ [mm]	TE-YRT
	17,9 ... 18,2	TE-YRT 18/320
	19,9 ... 20,2	TE-YRT 20/320
	21,9 ... 22,2	TE-YRT 22/400
	24,9 ... 25,2	TE-YRT 25/400
	27,9 ... 28,2	TE-YRT 28/480
	29,9 ... 30,2	TE-YRT 30/540
	31,9 ... 32,2	TE-YRT 32/500
	34,9 ... 35,2	TE-YRT 35/600
	Ø d ₀ [inch]	TE-YRT
	0.764 ... 0.776	TE-YRT 3/4" / 12 1/2"
	0.862 ... 0.874	TE-YRT 7/8" / 15"
	1.008 ... 1.020	TE-YRT 1" / 17 1/2"
	1.146 ... 1.157	TE-YRT 1 1/8" / 20"
	1.374 ... 1.386	TE-YRT 1 3/8" / 25"

FIGURE 8B—MANUFACTURER'S PRINTED INSTALLATION INSTRUCTIONS (MPII)

DIVISION: 03 00 00—CONCRETE
Section: 03 16 00—Concrete Anchors

DIVISION: 05 00 00—METALS
Section: 05 05 19—Post-Installed Concrete Anchors

REPORT HOLDER:

HILTI, INC.

EVALUATION SUBJECT:

HILTI HIT-RE 500 V3 ADHESIVE ANCHORS AND POST-INSTALLED REINFORCING BAR CONNECTIONS IN CRACKED AND UNCRACKED CONCRETE

1.0 REPORT PURPOSE AND SCOPE**Purpose:**

The purpose of this evaluation report supplement is to indicate that the Hilti HIT RE 500 V3 Adhesive Anchoring System and Post-Installed Reinforcing Bar System for cracked and uncracked concrete, described in ICC-ES evaluation report [ESR-3814](#), has also been evaluated for compliance with the codes noted below as adopted by the Los Angeles Department of Building and Safety (LADBS).

Applicable code editions:

- 2023 *City of Los Angeles Building Code* ([LABC](#))
- 2023 *City of Los Angeles Residential Code* ([LARC](#))

2.0 CONCLUSIONS

The Hilti HIT-RE 500 V3 Adhesive Anchoring System and Post-Installed Reinforcing Bar System for cracked and uncracked concrete, described in Sections 2.0 through 7.0 of the evaluation report [ESR-3814](#), complies with LABC Chapter 19, and the LARC, and is subject to the conditions of use described in this supplement.

3.0 CONDITIONS OF USE

The Hilti HIT RE 500 V3 Adhesive Anchoring System and Post-Installed Reinforcing Bar System described in this evaluation report supplement must comply with all of the following conditions:

- All applicable sections in the evaluation report [ESR-3814](#).
- The design, installation, conditions of use and identification of the Hilti HIT-RE 500 V3 Adhesive Anchoring System and Post-Installed Reinforcing Bar System are in accordance with the 2021 *International Building Code*® (IBC) provisions noted in the evaluation report [ESR-3814](#).
- The design, installation and inspection are in accordance with additional requirements of LABC Chapters 16 and 17, as applicable.
- Under the LARC, an engineered design in accordance with LARC Section R301.1.3 must be submitted.
- The allowable and strength design values listed in the evaluation report and tables are for the connection of the adhesive anchors and post installed reinforcing bars to the concrete. The connection between the adhesive anchors or post installed reinforcing bars and the connected members shall be checked for capacity (which may govern).
- For use in wall anchorage assemblies to flexible diaphragm, anchors shall be designed per the requirements of City of Los Angeles Information Bulletin P/BC 2020-071.

This supplement expires concurrently with the evaluation report, reissued January 2025.

DIVISION: 03 00 00—CONCRETE
Section: 03 16 00—Concrete Anchors

DIVISION: 05 00 00—METALS
Section: 05 05 19—Post-Installed Concrete Anchors

REPORT HOLDER:

HILTI, INC.

EVALUATION SUBJECT:

HILTI HIT-RE 500 V3 ADHESIVE ANCHORS AND POST-INSTALLED REINFORCING BAR CONNECTIONS IN CRACKED AND UNCRACKED CONCRETE

1.0 REPORT PURPOSE AND SCOPE

Purpose:

The purpose of this evaluation report supplement is to indicate that the Hilti HIT-RE 500 V3 Adhesive Anchors and Post-Installed Reinforcing Bar System in Concrete, described in ICC-ES evaluation report ESR-3814, have also been evaluated for compliance with the codes noted below.

Applicable code editions:

- 2023 Florida Building Code—Building
- 2023 Florida Building Code—Residential

2.0 CONCLUSIONS

The Hilti HIT-RE 500 V3 Adhesive Anchor System and Post-Installed Reinforcing Bar System, described in Sections 2.0 through 7.0 of ICC-ES evaluation report ESR-3814, comply with the *Florida Building Code—Building* and the *Florida Building Code—Residential*, provided the design requirements are determined in accordance with the *Florida Building Code—Building* or the *Florida Building Code—Residential*, as applicable. The installation requirements noted in ICC-ES evaluation report ESR-3814 for the 2021 *International Building Code*® meet the requirements of the *Florida Building Code—Building* or the *Florida Building Code—Residential*, as applicable.

Use of the Hilti HIT-RE 500 V3 Adhesive Anchor System and Post-Installed Reinforcing Bar System has also been found to be in compliance with the High-Velocity Hurricane Zone provisions of the *Florida Building Code—Building* and the *Florida Building Code—Residential* with the following condition.

- a) For anchorage of wood members, the connection subject to uplift must be designed for no less than 700 pounds (3114 N).

For products falling under Florida Rule 61G20-3, verification that the report holder's quality-assurance program is audited by a quality-assurance entity approved by the Florida Building Commission for the type of inspections being conducted is the responsibility of an approved validation entity (or the code official, when the report holder does not possess an approval by the Commission).

This supplement expires concurrently with the evaluation report, reissued January 2025.