

# HILTI

# VCU 40

Operating instructions

en



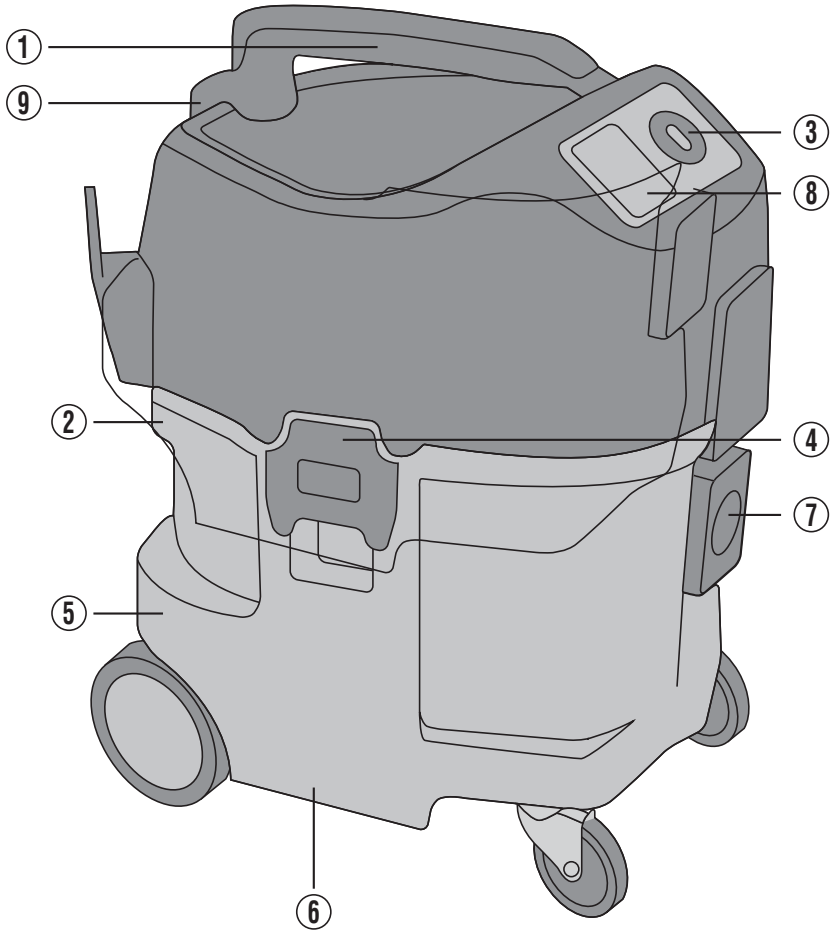

This Product is Certified  
Ce produit est homologué  
Producto homologado por  
Este producto está registrado



2

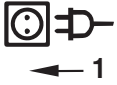

AUTO 0 MAN

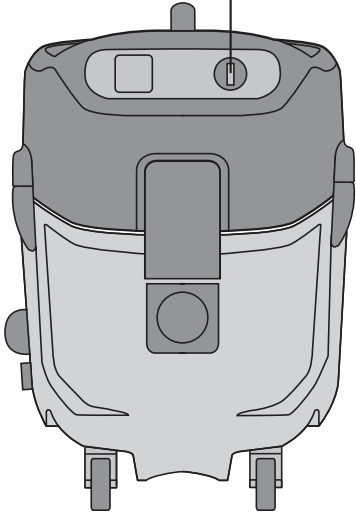
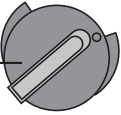

3

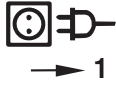

AUTO 0 MAN



2.5

4

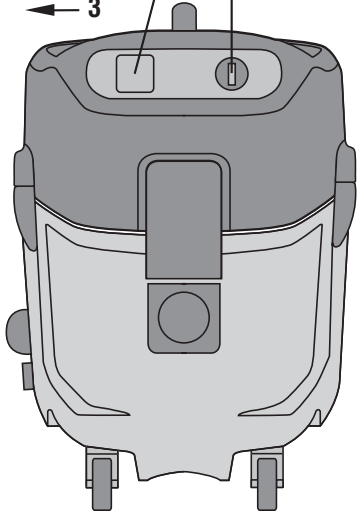

4

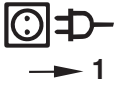

3

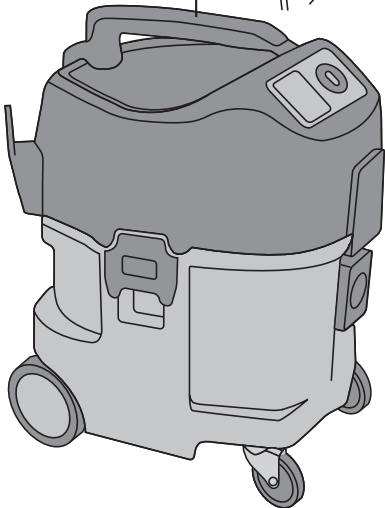
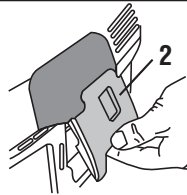

5

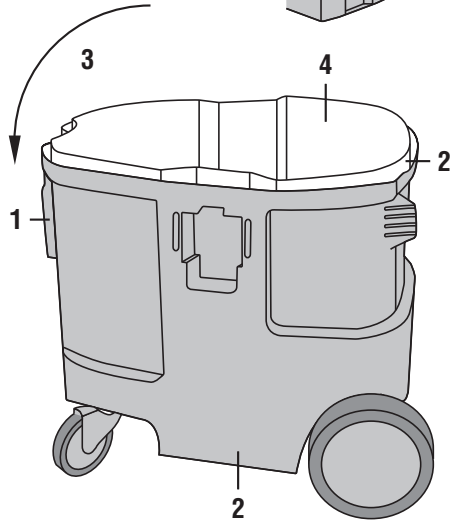
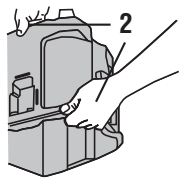

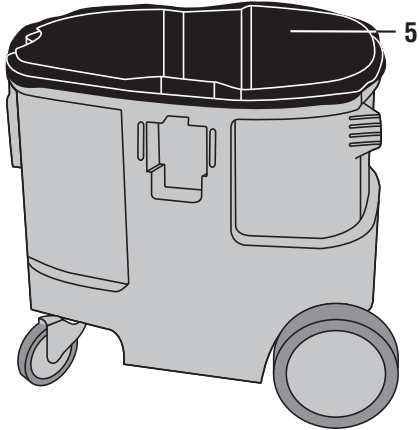
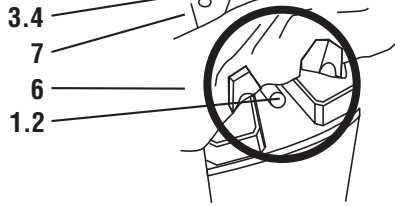
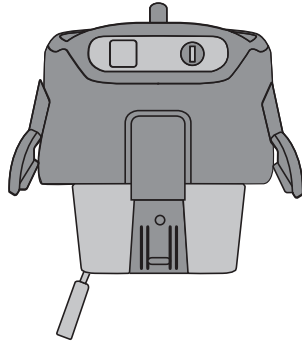
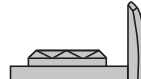
**6****7****3****2****1**

# VCU 40 wet / dry vacuum cleaner

*It is essential that the operating instructions are read before the tool is operated for the first time.*

*Always keep these operating instructions together with the tool.*

*Ensure that the operating instructions are with the tool when it is given to other persons.*

## Operating controls and components 1

- ① Grip
- ② Accessory compartment
- ③ Control switch (with suction power regulation)
- ④ Latch
- ⑤ Waste material container
- ⑥ Grip for emptying container
- ⑦ Hose socket
- ⑧ Electric socket
- ⑨ Supply cord stowage hook

Contents	Page
1. General information	1
2. General safety rules	2
3. Specific safety rules and symbols	4
4. Description	5
5. Tools and accessories	6
6. Technical data	6
7. Before use	6
8. Operation	7
9. Care and maintenance	8
10. Troubleshooting	9
11. Disposal	10
12. Warranty	10

## 1. General information

### 1.1 Signal words and their meaning

#### -CAUTION-

Used to draw attention to a potentially dangerous situation which could lead to minor personal injury or damage to the equipment or other property.

#### -NOTE-

Used to draw attention to an instruction or other useful information.

### 1.2 Pictograms

#### Warning signs



General warning



Warning: electricity



Warning: caustic substances



Warning: explosive substances

#### Obligation signs



Wear protective clothes



Do not transport by crane.

#### Symbols



Read the operating instructions before use.

**1** These numbers refer to the corresponding illustrations. The illustrations can be found on the fold-out cover pages. Keep these pages open while studying the operating instructions.

In these operating instructions, the VCU 40 wet / dry vacuum cleaner is referred to as the “the appliance”.

#### Location of identification data on the tool

The type designation can be found on the rating plate and the serial number on the side of the motor housing. Make a note of this data in your operating instructions and always refer to it when making an enquiry to your Hilti representative or service department.

Type: \_\_\_\_\_

Serial no.: \_\_\_\_\_

en

## 2. General safety rules

### 1. Warning

#### Read and understand all instructions.

Failure to follow all instructions listed below may result in electric shock, fire and/or serious personal injury.

#### - SAVE THESE INSTRUCTIONS -

**1.1 Warning** – To reduce the risk of fire, electric shock, or injury:

- Do not leave appliance when plugged in. Unplug from outlet when not in use and before servicing.
- Do not use outdoors or on wet surfaces.
- Do not allow to be used as a toy. Close attention is necessary when used by or near children.
- Use only as described in this manual. Use only manufacturer's recommended attachments.
- Do not use with damaged cord or plug. If appliance is not working as it should, has been dropped, damaged, left outdoors, or dropped into water, return it to a service center.
- Do not pull or carry by cord, use cord as a handle, close a door on cord, or pull cord around sharp edges or corners. Do not run appliance over cord. Keep cord away from heated surfaces.
- Do not unplug by pulling on cord. To unplug, grasp the plug, not the cord.
- Do not handle plug or appliance with wet hands.
- Do not put any object into openings. Do not use with any opening blocked, keep free of dust, lint, hair, and anything that may reduce air flow.
- Do not pick up anything that is burning or smoking, such as cigarettes, matches, or hot ashes.
- Do not use without dust bag and/or filters in place.
- Turn off all controls before unplugging.
- Use extra care when cleaning on stairs.
- Do not use to pick up flammable or combustible liquids such as gasoline or use in areas where they may be present.

For a grounded appliance: "Connect to a properly grounded outlet only. See Grounding Instructions.

### 2. Work area

**2.1 Keep your work area clean and well lit.** Cluttered benches and dark areas invite accidents.

**2.2 Do not operate power tools or electric appliances in explosive atmospheres, such as in the presence of flammable liquids, gases, or dust.** Power tools create sparks which may ignite the dust or fumes.

**2.3 Keep bystanders, children and visitors away while operating a power tool.** Distractions can cause you to lose control.

### 3. Electrical safety

**3.1 Grounded tools and electric appliances must be plugged into an outlet properly installed and grounded in accordance with all codes and ordinances. Never remove the grounding prong or modify the plug in any way. Do not use any adaptor plugs. Check with a qualified electrician if you are in doubt as to whether the outlet is properly grounded.** If the tools or appliances should electrically malfunction or break down, grounding provides a low resistance path to carry electricity away from the user.

**3.2 Avoid body contact with grounded surfaces such as pipes, radiators, ranges and refrigerators.** There is an increased risk of electric shock if your body is grounded.

**3.3 Do not expose power tools or electric appliances to rain or wet conditions.** Water entering a power tool or appliance will increase the risk of electric shock.

**3.4 Do not abuse the cord. Never use the cord to carry the tools or pull the plug from an outlet. Keep the cord away from heat, oil, sharp edges or moving parts. Replace damaged cords immediately.** Damaged cords increase the risk of electric shock.

**3.5 When operating a power tool or electric appliance outside, use an outdoor extension cord marked «W-A» or «W».** These cords are rated for outdoor use and reduce the risk of electric shock.

### 4. Personal safety

**4.1 Stay alert, watch what you are doing and use common sense when operating a power tool. Do not use a tool while tired or under the influence of drugs, alcohol, or medication.** A moment of inattention while operating power tools may result in serious personal injury.

**4.2 Dress properly. Do not wear loose clothing or jewelry. Contain long hair. Keep your hair, clothing, and gloves away from moving parts.** Loose clothes, jewelry, or long hair can be caught in moving parts.

**4.3 Avoid accidental starting. Be sure the tool or electric appliance is switched off before plugging in.** Carrying tools with your finger on the switch or plugging in tools that have the switch on invites accidents.

**4.4 Remove adjusting keys or wrenches before turning the tool on.** A wrench or a key that is left attached to a rotating part of the tool may result in personal injury.

**4.5 Do not overreach. Keep proper footing and balance at all times.** Proper footing and balance enables better control of the tool in unexpected situations.

4.6 **Use safety equipment. Always wear eye protection.** Dust mask, non-skid safety shoes, hard hat or hearing protection must be used for appropriate conditions.

## 5. Use and care of the tool or electric appliances

5.1 **Use clamps or other practical means to support and secure the workpiece to a stable platform.** Holding the work by hand or against your body is unstable and may lead to loss of control.

5.2 **Do not force the tool. Use the correct tool for your application.** The correct tool will do the job better and safer at the rate for which it is designed.

5.3 **Do not use the tool or electric appliances if the switch does not turn it on or off.** Any tool or electric appliances that cannot be controlled with the switch is dangerous and must be repaired.

5.4 **Disconnect the plug from the power source before making any adjustments, changing accessories, or storing the tool or electric appliances.** Such preventive safety measures reduce the risk of starting the tool or electric appliances accidentally.

5.5 **Store idle tools out of reach of children and other untrained persons.** Tools are dangerous in the hands of untrained users.

5.6 **Maintain tools with care. Keep cutting tools sharp and clean.** Properly maintained tools with sharp cutting edges are less likely to bind and are easier to control.

5.7 **Check for misalignment or binding of moving parts, breakage of parts and any other condition that may affect the tool's operation. If damaged, have the tool serviced before using.** Many accidents are caused by poorly maintained tools.

5.8 **Use only accessories that are recommended by the manufacturer for your model.** Accessories that may be suitable for one tool may become hazardous when used on another tool.

## 6. Service

6.1 **Electric tools or appliances must be serviced only by qualified repair personnel.** Service or maintenance performed by unqualified personnel could result in a risk of injury.

6.2 **When servicing an electric tool or appliance, use only identical replacement parts. Follow instructions in the maintenance section of this manual.** Use of unauthorized parts or failure to follow maintenance instructions may create a risk of electric shock or injury.

6.3 **Grounding instructions.** This appliance must be grounded. If it should malfunction or breakdown, grounding provides a path of least resistance for electric current to reduce the risk of electric shock. This appliance is equipped with a cord having an equip-

ment-grounding conductor and grounding plug. The plug must be inserted into an appropriate outlet that is properly installed and grounded in accordance with all local codes and ordinances.

**Warning** – Improper connection of the equipment-grounding conductor can result in a risk of electric shock. Check with a qualified electrician or service person if you are in doubt as to whether the outlet is properly grounded. Do not modify the plug provided with the appliance.

This appliance is for use on a normal 120-volt circuit and has a grounding attachment plug that locks like the plug illustrated in sketch A in figure "Grounding methods". Make sure that the appliance is connected to an outlet having the same configuration as the plug. No adaptor should be used with this appliance.

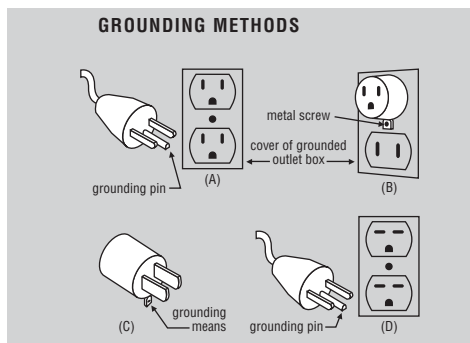

## 3. Specific safety rules and symbols

### 3.1 Basic information concerning safety

In addition to the information relevant to safety given in each of the sections of these operating instructions, the following points must be strictly observed at all times.

**WARNING:** Read all instructions! Failure to observe the following instructions may lead to electric shock, fire and/or serious personal injury.

### 3.2 Take the necessary precautions to make the workplace safe



- Ensure that the workplace is well lit.
- Ensure that the workplace is well ventilated.
- Keep the working area tidy. Objects which could cause injury should be removed from the working area. Untidiness at the workplace may lead to accidents.
- Keep other persons, children in particular, outside the working area.
- Do not permit other persons to touch the appliance or the extension cord.
- Avoid unusual body positions. Work from a secure stance and stay in balance at all times.
- Wear non-slip boots or shoes.
- To avoid tripping and falling when working, always lead the supply cord, extension cord and extraction hose away to the rear.
- Do not transport the appliance by crane.
- Ensure that the appliance is switched off before inserting the supply cord plug in the mains socket.

### 3.3 General safety precautions



- Operate the appliance only as directed and only when it is in faultless condition.
- Never leave the appliance unsupervised.
- Ensure that the appliance is switched off before inserting the supply cord plug in the mains socket.
- Take the surrounding conditions into account. Do not expose the appliance to rain or snow and do not use it in damp or wet areas. Do not use the appliance where there is a risk of fire or explosion.
- Do not use the appliance for purposes for which it was not intended.
- To avoid risk of injury, use only original Hilti accessories and ancillary equipment. Use of accessories or items of auxiliary equipment other than those listed in the operating instructions may present a risk of personal injury.
- When not in use, the appliance must be stored in a dry place, locked up or out of reach of children.
- Disconnect the supply cord plug from the socket when the appliance is not in use (e.g. during pauses between

work), before maintenance and before changing the filter.

- Switch the appliance off before transporting it.
- Check the appliance for possible damage. Protective devices and any parts that may have suffered slight damage should be checked for correct operation and functionality before further use of the appliance. Safety devices or other parts that are found to be damaged must be replaced or repaired properly by an authorized repair workshop unless otherwise indicated in the operating instructions.
- Check that the filter is mounted in the correct position.

### 3.3.1 Mechanical hazards



- Follow the instructions concerning care and maintenance.
- Check whether parts have suffered damage and that all moving parts function faultlessly without sticking. All parts must be fitted correctly and fulfil all of the conditions necessary to ensure faultless operation of the appliance.

### 3.3.2 Electrical hazards



- Protect yourself from electric shocks. Avoid body contact with earthed objects, e.g. pipes and radiators.
- Check the condition of the appliance's supply cord at regular intervals. The supply cord should be replaced by a trained electrical specialist if damage is found. Also regularly check the condition of extension cords and replace these if damage is found.
- Check the condition of the appliance including the supply cord and extension cord as well as the plug connections. Do not operate the appliance if damage is found, if the appliance is not complete or if its controls cannot be operated faultlessly.
- Do not touch the supply cord in the event of it becoming damaged while working. Disconnect the supply cord plug from the socket.
- Damaged switches must be replaced at a Hilti service center. Do not use the appliance if it cannot be switched off and on properly.
- The appliance should be repaired only by a trained electrical specialist (Hilti service center) using original Hilti spare parts. Failure to observe this point may result in a risk of accident to the user.
- Do not use the supply cord for purposes for which it is not intended. Do not pull the plug out of the socket by pulling the supply cord.
- Do not expose the supply cord to heat, oil or sharp edges.



- When working outdoors, use only extension cords approved and correspondingly marked for this application.
- In the event of a power cut: switch the appliance off and unplug the supply cord.
- Avoid using extension cords with multiple sockets and operating several appliances simultaneously.
- Never operate the appliance when it is dirty or wet. Dust or dampness on the surface of the appliance make it difficult to hold and, under unfavorable conditions, may lead to electric shocks.
- Never spray the top section of the appliance with water. This presents a risk of personal injury and may cause damage to the appliance.
- The connections used for supply cords, extension cords or electric tool connecting cables must offer protection from sprayed water.
- Grip the plug when unplugging the supply cord (do not pull or tug at the supply cord).
- Never pull the vacuum cleaner by the supply cord when moving it to a new working position.

- Inflammable, explosive or caustic liquids (gasoline, solvents, acids (pH < 5), alkalies (pH > 12.5) etc.) must not be picked up with the appliance.
- Wear protective clothing when working with mineral-based drilling slurry and avoid skin contact (pH > 9 → caustic).

**3.3.3 Types of dust**



- Inflammable or explosive dusts (magnesium or aluminium dust etc.) must not be picked up with the appliance.
- Dusts that present a health hazard must not be picked up with the appliance.

**3.5 Thermal hazards**

- Hot materials must not be picked up with the appliance (glowing cigarettes, hot ash, etc.)

**3.4 Requirements to be met by users**

- The appliance is intended for professional use.
- The appliance may be operated, serviced and repaired only by authorized, trained personnel. This personnel must be informed of any special hazards that may be encountered.
- Always concentrate on the job you are doing. Proceed carefully and do not use the appliance if your full attention is not on the job.

**3.5 Personal protective equipment**



- Wear protective clothing when working with mineral-based drilling slurry and avoid skin contact (pH > 9 → caustic).

**3.3.4 Types of liquid**



**Symbols used on the tool:**

V	.....	volts
~	.....	alternating current
Hz	.....	hertz
W	.....	watts
A	.....	amperes
⏚	.....	protective grounding

**4. Description**

**4.1 Use of the tool as directed**

The VCU 40 is a universal industrial vacuum cleaner with efficient self-cleaning filter system for dry dust. It can be used for dry or wet vacuum cleaning applications. The appliance is particularly suitable for removing large quantities of mineral-based dust in conjunction with Hilti diamond grinders, cutters, rotary hammer drills and dry-cutting diamond coring machines. The appliance may also be used for the suction removal of materials in liquid form. It is suitable for the suction removal of mineral-based drilling slurry. The appliance may be used for cleaning work on construction sites or in workshops for wet and dry vacuum cleaning applications.



- The appliance must not be used to pick up explosive substances, substances hazardous to health, glowing / burning or inflammable dusts (e.g. magnesium or aluminium dust etc.) or inflammable or caustic liquids (e.g. gasoline, solvents, acids etc.).
- The appliance must not be operated when laid down on its side (always operate in upright position).
- Do not use the appliance as a substitute for a ladder.
- Do not use the appliance for continuous, stationary operation in an automatic or semi-automatic system.
- Manipulation or modification of the appliance is not permissible.
- To avoid the risk of injury, use only original Hilti accessories and auxiliary equipment.

- The appliance and its auxiliary equipment may present risks or hazards when used incorrectly by untrained personnel or when used not as directed.

#### 4.2 Items supplied as standard equipment

- 1 VCU 40 vacuum cleaner
- 1 D36 hose (D1.4 inch hose), length 5 m (16.4 feet), with rotating connector and suction nozzle connector
- 1 Filter
- 1 Disposal bag
- 1 Operating instructions

en

## 5. Tools and accessories

Disposal bag  
 Accessory sets  
 Suction hose  
 Hose connectors  
 Tapered adaptor

## 6. Technical data

### Appliance

Nominal power rating	1100 W	1100 W	1200 W	1200 W	1200 W	1200 W	1200 W
Nominal voltage rating	110 V	110 V	120 V	220 V	230 V	230 V	240 V
Power rating of built-in supply socket for electric tools	–	1800 W	–	–	1100 W	2400 W	2400 W
Mains frequency	50–60 Hz						
Weight of appliance	17 kg (37.4 lb)						
Dimensions (L×W×H)	506×476×655 mm (20 x 18.7 x 25.8 in)						
Supply cord length	7.5 m (24.6 ft)						
Supply cord type	H 07 RN-F 3G1.52 (US: SJTW-A AWG 16/3)						
Max. suction performance (air)	1200 W = 60 l/s				1100 W = 50 l/s		
Max. vacuum	1200 W = 23000 Pa (230 mbar)				1100 W = 21000 Pa (210 mbar)		
Filter surface area	0.7 m <sup>2</sup> (7.5 sq ft)						
Noise pressure level	60 dB (A) at a distance of 1 m (3.2 ft)						
Container volume	40 l (10.6 gal)						
Effective dust capacity	15 l (4 gal)						
Effective water capacity	20 l (5.3 gal)						
Suction hose	36 mm (1.4 in) dia., length 5 m (16.4 ft), rotating connector at vacuum cleaner end, suction nozzle connector at other end						
Air temperature	from –20 to +40°C (–4° F to +104° F)						
Automatic filter cleaning	approx. every 30 sec.						
Protection class	I						
Protection type	IP X4, protection against sprayed water						

Right of technical changes reserved!

## 7. Before use



### - NOTE -

- The mains voltage must comply with the information given on the rating plate.

- If an extension cord is used, observe the following minimum conductor cross sections: 1.5 mm<sup>2</sup> (0.02 sq in) for up to 20 m (65.6 ft) cord length, 2.5 mm<sup>2</sup> (0.03 sq in) for between 20 m (65.6 ft) and 50 m (164 ft) cord length.

### - NOTE -

The appliance must be switched off from the waste material container.

3. Remove the accessory. It must be unplugged from the mains supply before making adjustments, before cleaning or maintenance and before changing the disposal bag.

### 7.1 Initial operation

1. Open the two latches.
2. Lift the top sections and packaging from the waste material container.

### - NOTE -

Depending on the type of waste material to be picked up, a disposal bag may be fitted in the waste material container. When doing so, push the collar on the disposal bag firmly onto the hose socket.

4. Lift the top section onto the waste material container.
5. Close the two latches.
6. Connect the suction hose to the appliance.

### 7.2 Transport



- The appliance must not be carried when full.
- Empty the appliance before carrying it to a different location.
- Do not tip the appliance or lay it on its side for transport after sucking up liquids.

en

## 8. Operation



### 8.1 Operation without using the built-in electric socket 2

#### - NOTE -

Check that the appliance is switched off (control switch in "0" position) before plugging the supply cord into the electric socket.

1. Plug the supply cord into the electric socket.
2. Turn the control switch to the "MAN" position.

#### - NOTE -

The appliance starts after about 5 seconds (soft start function).

### 8.2 Operation using the built-in electric socket 3

#### - NOTE -

- Check that the electric tool is switched off before plugging the supply cord into the electric socket.
- The safety precautions and other information listed in the operating instructions for the electric tool connected to the appliance must be observed.
- Check that the maximum power input rating of the electric tool connected to the appliance is within the maximum permitted power rating for the electric socket (Please refer to the table "Technical data" and the information printed on the electric socket.)

1. Unplug the appliance supply cord from the mains socket.
2. Plug the electric tool supply cord into the electric socket on the appliance.
3. Plug the appliance supply cord into the mains socket.
4. Turn the control switch to the "AUTO" position.
5. Switch on the electric tool.

#### - NOTE -

- The appliance starts after about 5 seconds (soft start function).
- The appliance continues to run for a few seconds after switching off the electric tool in order to remove any waste material from the hose.

### 8.3 Picking up dry dust

#### - NOTE -

The following points must be observed when using the appliance to pick up dry dust (mineral-based dust in particular):

- A disposal bag (Hilti accessory) must always be fitted in the waste material container before using the appliance to pick up dry dust. The waste material collected can then be disposed of cleanly and easily.
- Before picking up dry dust, take care to ensure that the filter element is not damp after having previously used the vacuum cleaner to pick up liquids. A damp filter element quickly becomes blocked when dry dust is picked up. Accordingly, the filter element should be rinsed and dried or a dry filter element fitted before picking up dry dust.

### 8.4 Picking up liquids

#### - NOTE -

Always use a filter element when using the appliance to pick up liquids.

#### 8.4.1 Before picking up liquids

- Remove the disposal bag from the waste material container.
- Check that the container level sensor is not blocked. Clean it if necessary.

#### 8.4.2 When picking up liquids

- If possible, use a separate filter element for picking up liquids.
- If foaming occurs, switch off the appliance immediately and empty the waste material container.

#### 8.4.3 After picking up liquids

- Empty the liquid out of the container. Clean the container and filter to remove any dirt deposits.
- Do not refit the top section of the vacuum cleaner immediately. Allow the filter element and inside of the container to dry.

#### 8.5 Adjusting the suction force

Adjust the suction force by turning the control switch. This permits the suction force to be adjusted precisely for various cleaning jobs.

#### 8.6 After use

1. Switch off the electric tool.
2. Turn the control switch on the appliance to the "0" position.
3. Unplug the supply cord from the mains socket.
4. Coil up the supply cord and hang it over the supply cord storage hook.
5. Empty the container and clean the appliance.
6. Coil up the suction hose.
7. Store the appliance in a secure place in a dry room where it cannot be used by unauthorized persons.

#### 8.7 Emptying the waste material container

##### - NOTE -

After using the appliance to pick up dry dust, it is recommended that the filter is cleaned as described at section 9.1 before emptying the waste material container. This will increase the life of the filter significantly.

#### 8.7.1 Before emptying the waste material container, proceed as follows:

1. Unplug the supply cord from the mains socket.
2. Open the two latches.

3. Lift the top section off the waste material container and place it on a level surface.

#### 8.7.2 After emptying the waste material container, proceed as follows:

1. Place the top section of the vacuum cleaner on the waste material container and close the two latches.
2. Fit the suction hose to the hose socket.
3. Plug the supply cord into the mains socket.

#### 8.8 Emptying the waste material container without disposal bag (liquids)

1. Remove the suction hose from the hose socket.
2. Grip the waste material container with one hand under its bottom edge and the other hand at its top edge.
3. Empty the waste material container by tipping it.

##### - NOTE -

The waste material must be disposed of in accordance with the applicable regulations.

4. Clean the edge of the waste material container, the hose socket and the hose connector.

#### 8.9 Emptying the waste material container with disposal bag (dry dust)

1. Release the disposal bag from the edge of the waste material container.
2. Close the disposal bag with the cable tie provided (attached to the outside of the bag).
3. Carefully release the disposal bag collar from the hose socket.
4. Close the disposal bag collar with the slider provided.

##### - NOTE -

The waste material must be disposed of in accordance with the applicable regulations.

5. Clean the waste material container.
6. Fit a new disposal bag in the waste material container.
7. Push the collar on the disposal bag firmly onto the hose socket.

## 9. Care and maintenance

#### 9.1 Cleaning the filter (complete cleaning)

The filter is cleaned automatically during operation. Nevertheless, it is necessary to clean the filter manually before each period of use and if it becomes very dirty during use.

1. Switch off the appliance.
2. Cover the suction nozzle opening or the end of the suction hose with the palm of the hand.
3. Switch on the appliance (switch position "MAN") and allow it to run for approx 10 seconds while the suction opening remains closed with the palm of the hand.

Water and a cloth can also be used to clean the filter (do not use a high-pressure cleaning system).

Mineral dust may clog the filter if cleaning is neglected, thus negatively affecting suction performance and reducing the life of the filter accordingly.

##### - NOTE -

Do not knock the filter against hard surfaces when cleaning it and do not use hard or pointed objects to assist cleaning. This will reduce the life of the filter.

##### - NOTE -

The filter is a wearing part. It should be replaced at least every six months or more frequently if the appliance is subjected to heavy use.

**9.2 Changing the filter**

**-CAUTION-**

Never use the appliance without a filter!

**9.2.1 Opening the appliance 4**

1. Unplug the supply cord from the mains socket.
2. Open the two latches.
3. Lift the top section off the waste material container.

**9.2.2 Removing the filter 7**

1. Release the securing clip.
2. Lift off the cover.
3. Remove the filter.

**9.2.3 Fitting the filter**

1. Fit the new filter.
2. Place the cover on the filter.
3. Secure the filter and the cover with the clip.

**9.2.4 Closing the appliance**

1. Lift the top section of the appliance onto the waste material container.
2. Close the two latches.
3. Plug the supply cord into the mains socket.

**9.3 Caring for the appliance**

1. Never operate the appliance if the ventilation slots are blocked! Clean the ventilation slots carefully using a dry brush.

2. Use a cloth to clean the outside of the appliance at regular intervals. Do not use a spray or steam cleaning system or running water for cleaning. This may negatively affect the electrical safety of the appliance.
3. Always keep the grips on the appliance free from oil and grease.
4. Do not use cleaning agents containing silicone.

**9.4 Maintenance**

**- NOTE -**

– Check all external parts of the appliance for damage at regular intervals and ensure that all operating controls function faultlessly. Do not operate the appliance when parts are found to be damaged or if the operating controls do not function faultlessly. Have the appliance repaired at a Hilti Service Center if necessary.

**-CAUTION-**

- The electrical section of the appliance may be repaired only by trained electrical specialists.
- Use only original Hilti accessories and spare parts. Use of other parts may negatively affect safety of the appliance.
- Do not modify the appliance in any way. This could put present a safety risk.

**9.5 Checking after cleaning and maintenance**

After cleaning and maintenance, check that all parts of the appliance have been fitted and that they function correctly.

**10. Troubleshooting**

<b>Fault</b>	<b>Possible cause</b>	<b>Remedy</b>
Drop in suction performance	Waste disposal bag is full.	Replace the waste disposal bag (see section 8.9).
	Filter is heavily soiled.	Complete cleaning necessary (see section 9.1). Change the filter if necessary (see section 9.2).
	Hose or vacuum enclosure of the appliance is blocked.	Clean the hose and vacuum enclosure.
	Suction power set too low.	Increase the suction power (see section 8.5).
	Seal at the edge of the appliance top section and the waste material container is dirty or defective.	Clean or replace the seal.
Dust is blown out of the appliance	Hole in the hose.	Fit a new hose.
	Filter not fitted correctly.	Fit the filter correctly.
	Filter retaining disc is not fitted.	Fit the filter retaining disc correctly.
	Filter is damaged.	Fit a new filter.
The appliance switches on and off unexpectedly or static electric discharges are felt by the user	Electrostatic charge is not being dissipated: The appliance is not connected to an earthed/grounded socket.	Connect the appliance to an earthed/grounded socket.
The motor stops running	Fuse for the mains socket has been tripped.	Reset or replace the fuse. If it trips again, find the cause of the high current.

	Motor thermal protection device has been activated.	Switch the appliance off and allow it to cool for approx. 5 min. If the motor then doesn't start, contact Hilti customer service.
	Motor thermal protection device switches the motor off repeatedly as the ventilation slots are blocked.	Clean the ventilation slots carefully with a dry brush.
The motor doesn't run in automatic mode	The electric tool connected is defective or not plugged in correctly.	Check the functionality of the electric tool connected and check that it is plugged in correctly.
No suction power when picking up liquids	The container is full.	Switch off the appliance. Empty the container (see section 8.8).
Deviation from nominal voltage	The electric supply impedance is too high.	Use a suitable extension cord (see section 7).

## 11. Disposal

Most of the materials from which Hilti appliances are manufactured can be recycled. The materials must be correctly separated before they can be recycled. In many countries, Hilti has already made arrangements for taking back your old appliances for recycling. Please ask your Hilti customer service department or Hilti sales representative for further information.

Should you wish to return the appliance yourself to a disposal facility for recycling, proceed as follows: Dismantle the appliance as far as possible without the need for special tools.

### Separate the individual parts as follows:

Parts / assembly	Main material	Recycling
Container and wheel assembly	PP and steel	Plastics and steel recycling
Vacuum unit	PP, motor and electronics	Electric appliance disposal
Extraction hose	EVA	Plastics recycling
Drilling slurry	*	

\* With regard to environmental aspects, allowing drilling slurry to flow directly into rivers, lakes or the sewerage system without suitable pre-treatment is problematical. Ask the local authorities for information about applicable regulations.

### We recommend the following pre-treatment:

- Allow the slurry to settle and dispose of the solid material at a construction waste disposal site (the addition of a flocculent may accelerate the settling process).
- Water from the drilling slurry (alkaline, pH value < 7) should be neutralized by adding an acidic neutralizing agent or large quantity of water before it is allowed to flow into the sewerage system.

## 12. Warranty

Hilti warrants that the tool supplied is free of defects in material and workmanship. This warranty is valid so long as the tool is operated and handled correctly, cleaned and serviced properly and in accordance with the Hilti Operating Instructions, all warranty claims are made within 12 months from the date of the sale (invoice date), and the technical system is maintained. This means that only original Hilti consumables, components and spare parts may be used in the tool. This warranty provides the free-of-charge repair or replacement of defective parts only. Parts requiring repair or replacement as a result of normal wear and tear are not covered by this warranty.

**Under no circumstances will Hilti be obligated for direct, indirect, incidental or consequential damages, losses or expenses in connection with, or by reason of, the use of, or inability to use the tool for any purpose. Hilti specifically excludes the implied warranties of merchantability and fitness for a particular purpose.**

For repair or replacement, send tool and/or related parts immediately upon discovery of the defect to the address of the local Hilti marketing organization provided.

This constitutes Hilti's entire obligation with regard to warranty and supersedes all prior or contemporaneous comments and oral or written agreements concerning warranties.

# HILTI

## Hilti Corporation

FL-9494 Schaan

Tel.: +423 / 234 21 11

Fax: +423 / 234 29 65

[www.hilti.com](http://www.hilti.com)



304373